

设计范例报告

标题	使用LYTSwitch™-4 LYT4322E设计的12 W高功率因数、非隔离、降压-升压式、可控硅调光的LED驱动器
规格	190 VAC – 265 VAC输入； 120V _{TYP} ，100mA输出
应用	A19 LED驱动器
作者	应用工程部
文档编号	DER-412
日期	2014年6月9日
修订版本	1.0

特色概述

- 单级功率因数校正(PFC)与精确恒流(CC)输出相结合
- 可控硅调光
 - 可兼容300 W至1200 W的各种可控硅调光器
 - 快速启动时间(<200 ms) – 无可见延迟
- 集成的保护及可靠性能
 - 输出短路保护，带自动恢复功能
 - 带更大迟滞的自动恢复热关断
 - 在AC电压跌落期间不会造成任何损坏
- 在230 VAC下，PF > 0.9
- 满足振铃波、差模输入浪涌和EN55015传导EMI要求

专利信息

此处介绍的产品和应用（包括产品之外的变压器结构和电路）可能包含一项或多项美国及国外专利，或正在申请的美国或国外专利。有关Power Integrations专利的完整列表，请参见www.powerint.com。Power Integrations按照在<http://www.powerint.com/ip.htm>中所述规定，向客户授予特定专利权利的许可。

Power Integrations

5245 Hellyer Avenue, San Jose, CA 95138 USA.

电话: +1 408 414 9200 传真: +1 408 414 9201

www.powerint.com

目录

1	简介.....	4
2	电源规格	7
3	电路原理图.....	8
4	电路描述	9
4.1	输入EMI滤波.....	9
4.2	功率电路	9
4.3	输出反馈	9
4.4	可控硅相位调光控制兼容性.....	10
4.5	空载/开路负载保护	10
4.6	可选关断电路	11
5	PCB布局	12
6	物料清单(BOM).....	14
6.1	不含关断电路的BOM	14
6.2	BOM With Turn-off Circuit.....	15
7	电感设计表格	17
8	电感规格	20
8.1	电气原理图.....	20
8.2	电气规格	20
8.3	材料	20
8.4	电感结构图.....	21
8.5	电感构造	21
9	性能数据	22
9.1	效率	22
9.2	线电压调整.....	23
9.3	功率因数	24
9.4	测试数据	25
10	调光性能数据.....	26
10.1	调光曲线.....	26
10.2	调光效率.....	27
10.3	调光期间的驱动器功耗	28
10.4	调光器兼容性列表	29
11	热性能	30
11.1	230VAC, 50Hz: 未连接调光器	30
11.2	230VAC, 50Hz: 连接调光器, 90°导通角	31
12	非调光(未连接调光器)波形.....	32
12.1	输入电压和输入电流波形.....	32
12.2	正常工作时的输出电流和输出电压	33
12.3	输出电流的升降.....	34
12.4	正常工作时的漏极电压和电流.....	35



12.5	启动时的漏极电压和电流	36
12.6	输出短路时的漏极电流和漏极电压	37
12.7	开路负载特性	38
12.8	电压跌落/缓升	38
13	调光波形.....	39
13.1	输入电压及输入电流波形 - 前沿调光器	39
13.2	输出电流波形 - 前沿调光器	40
13.3	输入电压及输入电流波形 - 后沿调光器.....	41
13.4	输出电流波形 - 后沿调光器	42
13.5	漏极电流波形 - 前沿调光器	43
14	传导EMI	44
14.1	测试设置	44
14.2	测试结果	45
15	输入浪涌.....	47
16	版本历史.....	48

重要说明: 虽然本电路板的设计满足安全隔离要求, 但工程原型尚未获得机构认证。因此, 必须使用隔离变压器向原型板提供AC输入, 以执行所有测试。



1 简介

本文档介绍的是一款非隔离、高功率因数(PF)、可控硅调光的LED驱动器，它可以在190 VAC至265 VAC（典型值为50Hz）的输入电压范围内为LED灯串提供额定电压120V、额定电流100 mA的驱动。该LED驱动器采用了LYTSwitch-4系列IC中的LYT4322E器件。

所采用的拓扑结构是单级、非隔离、降压-升压式拓扑结构，可满足本设计的高功率因数、恒流调整和调光要求。

本文档包含LED驱动器规格、电路原理图、PCB设计细节、物料清单、变压器规格文件和典型性能特征。

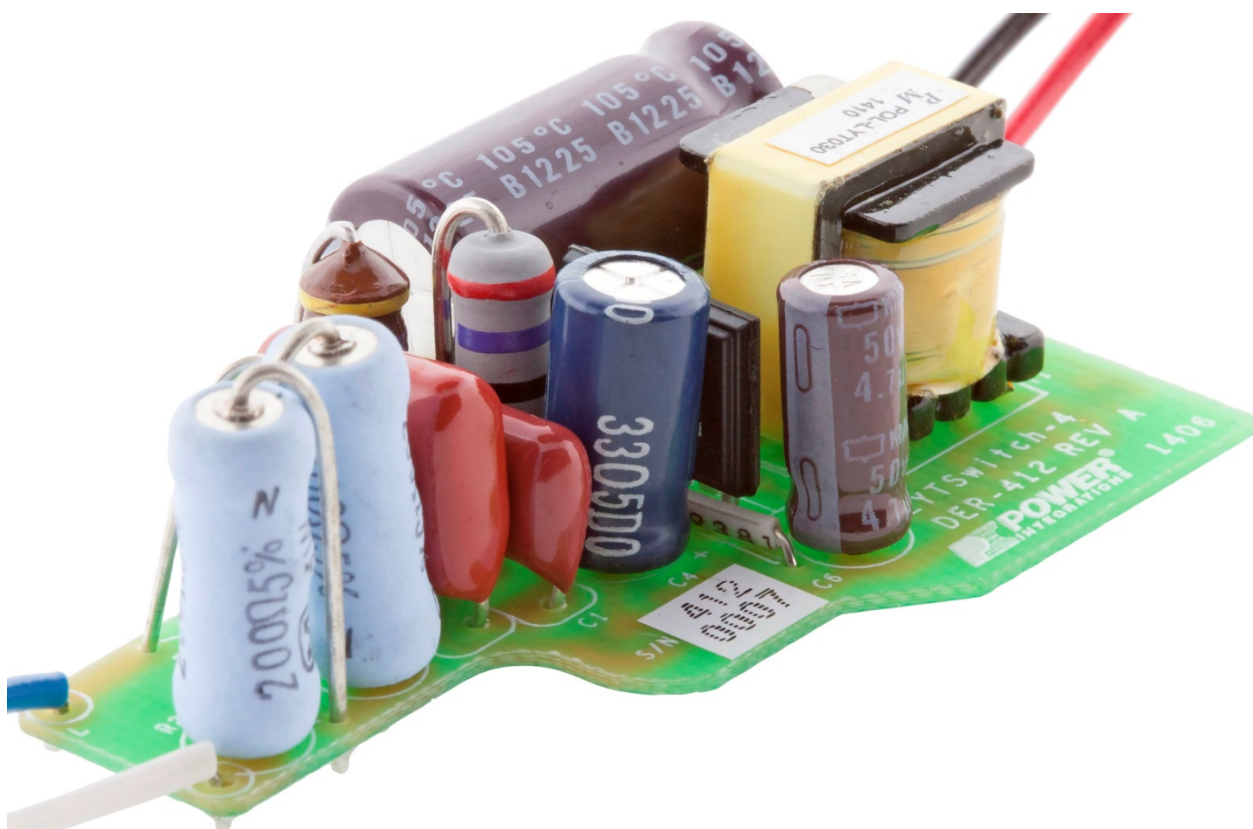

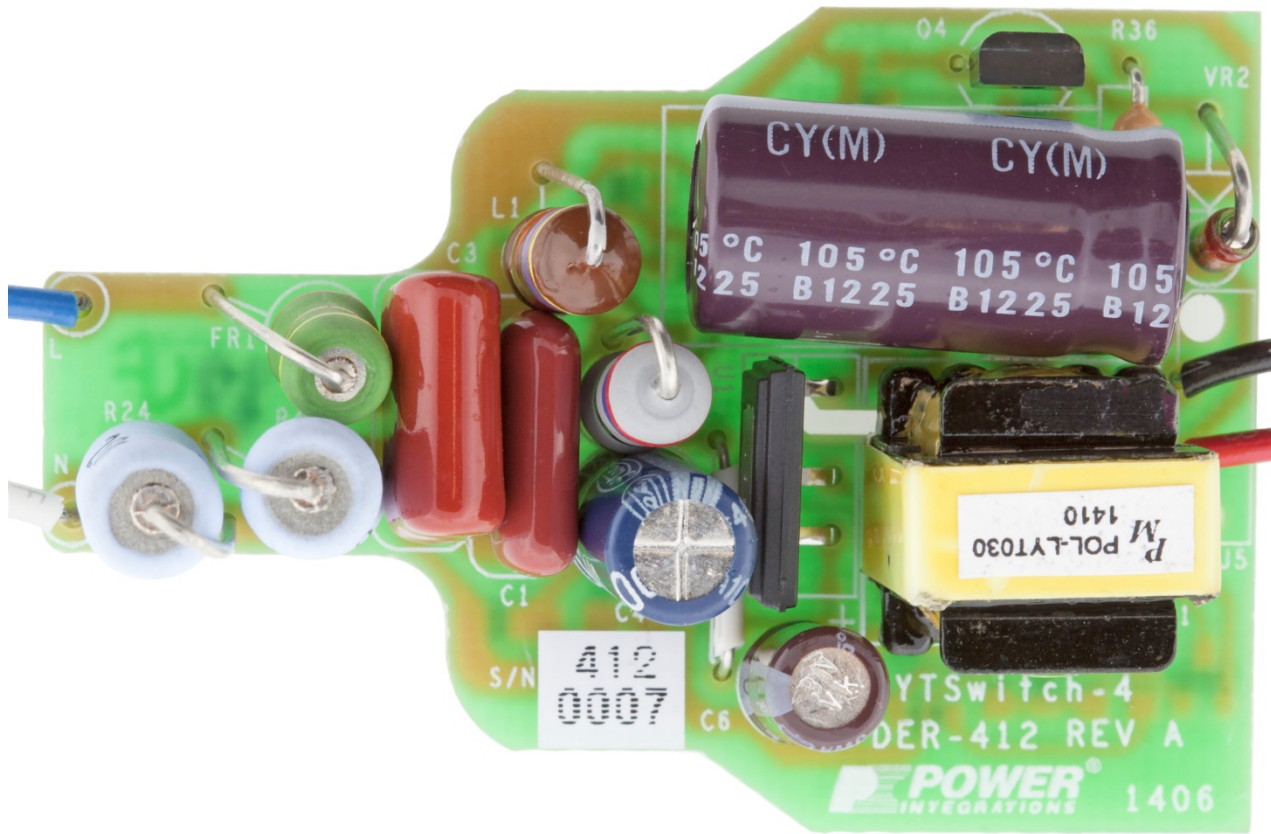

Figure 1 – Populated Circuit Board, Top View.



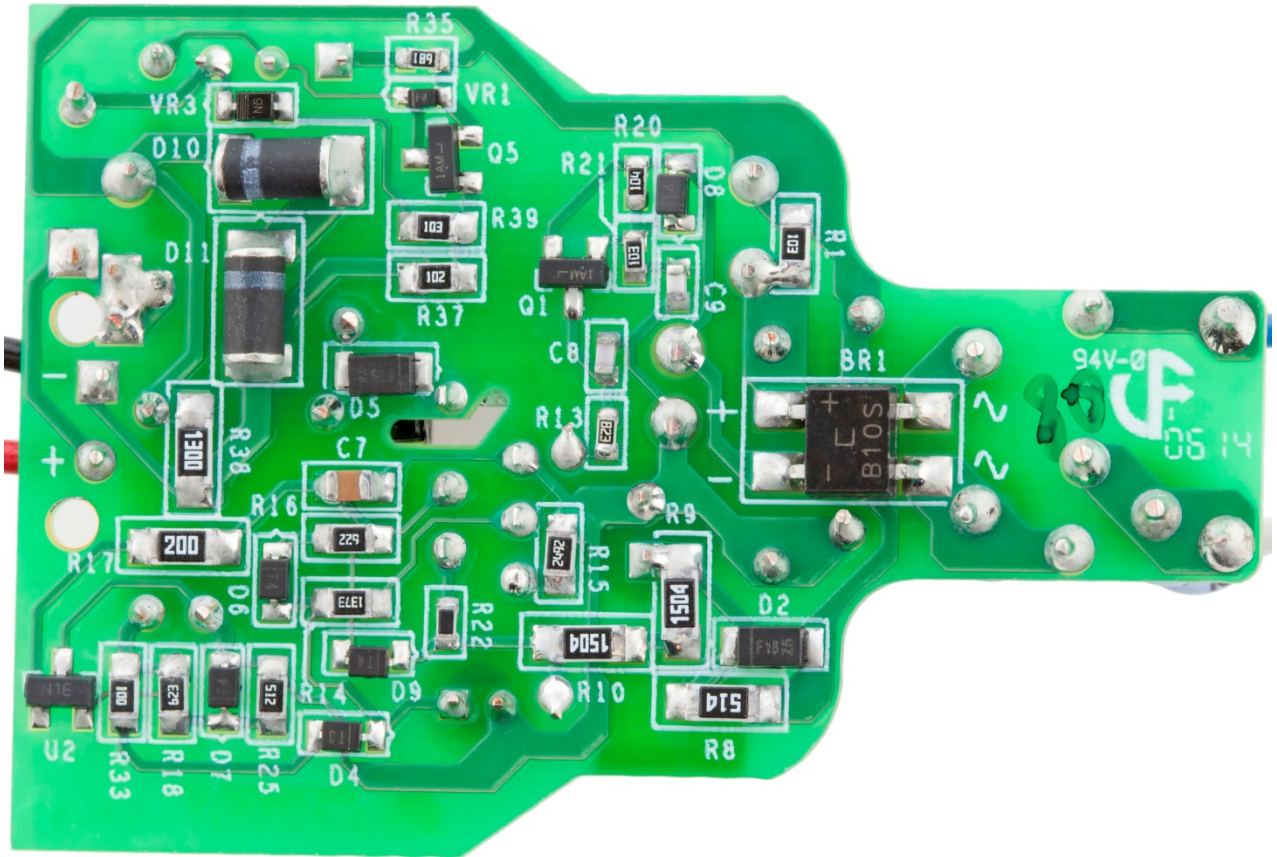

Figure 2 – Populated Circuit Board, Bottom View.



2 电源规格

下表所列为设计的最低可接受性能。实际性能可参考测量结果部分。

说明	符号	最小值	典型值	最大值	单位	备注
输入 电压 频率	V_{IN} f_{LINE}	190	230 50	265	VAC Hz	双导线 – 无P.E.
输出 输出电压 输出电流 总输出功率 连续输出功率	V_{OUT} I_{OUT} P_{OUT}	93	120 100 12	107	V mA W	$V_{OUT} = 120V, V_{IN} = 230 VAC, 25^{\circ}C$
效率 满载	η	84	85		%	在 $P_{OUT} 25^{\circ}C$ 、无调光器、 230VAC的条件下测得
环境 传导EMI 安全 振铃波(100 kHz) 差模(L1-L2) 差模浪涌			CISPR 15B / EN55015B 非隔离			
功率因数			0.9			在 $V_{OUT(TYP)}$ 、 $I_{OUT(TYP)}$ 以及230 VAC、50Hz条件下测得
环境温度	T_{AMB}		40		$^{\circ}C$	自然对流，敞开式 *在最终装配时应考虑采用灌封， 用以提高工作温度以及降低衰减电路 R24和R40上的热应力。



3 电路原理图

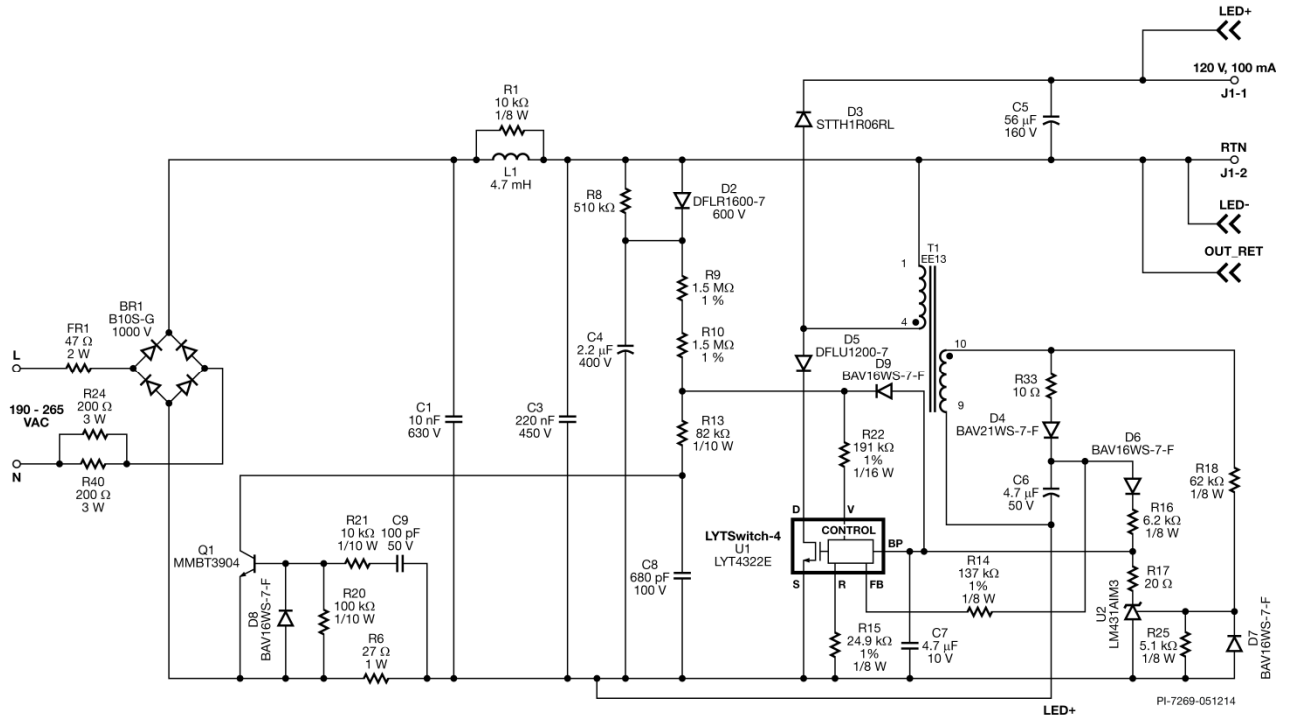

Figure 3 – Schematic.

Note: JP1 is 0Ω1206 smd resistor in R38 location if optional turn-off circuit is not used.



4 电路描述

LYTSwitch-4 LYT4322E器件是一种将控制器和725 V功率MOSFET集成在一起的器件，用于LED驱动器应用。LYTSwitch-4 LYT4322E可用于单级降压-升压式拓扑结构，提供调节的恒流隔离输出，同时使AC输入保持高功率因数。

4.1 输入EMI滤波

可熔电阻FR1在异常工作情况下提供元件故障保护。二极管桥堆BR1对AC线电压进行整流，电容C3为初级开关电流提供低阻抗通路（去耦）。为使功率因数保持在0.9以上，需要确保较低的输入电容（C1与C3之和）值。EMI滤波由电感L1以及电容C1和C3提供。

4.2 功率电路

本设计所采用的拓扑结构为低压端开关降压-升压式配置，可在190 VAC至265 VAC的输入电压范围内提供高功率因数和恒流输出。

输出二极管D3每当U1关断时就会导通，将能量传输至负载。在C3上的电压（整流后的输入AC）降到输出电压以下时，需要使用二极管D5来防止反向电流流经U1。

为向U1提供峰值输入电压信息，经整流AC的输入峰值经由D2对C4充电。然后电流经过R9和R10，注入U1的电压监测(V)引脚。电阻R9和R10所选取的值可以在230 VAC输入下提供~100 μ A的I_V（来自PIXIs设计表格）。

输入过压关断功能（通过V引脚电流检测）可使整流后的线电压承受能力（在浪涌和线电压陡升期间）达到内部功率MOSFET的额定725 BV_{DSS}。

电容C7对U1的BP引脚进行局部去耦，该引脚是内部控制器的供电引脚。在启动期间，C7从与U1的D引脚相连的内部高压电流源被充电至约6 V。

U1的参考引脚通过24.9k 电阻R15接地（源极）。

4.3 输出反馈

反馈信号来自由二极管D4和电容C6组成的网络所整流和滤波的偏置绕组。从电容C6产生的输出电压信息被电阻R14转换为反馈电流。该电流被LYT4322E用来调节转换器的输出电流。



4.4 可控硅相位调光控制兼容性

对于用低成本的可控硅前沿及后沿相控调光器提供输出调光的要求，我们需要在设计时进行一些权衡。

由于LED照明的功耗非常低，整灯吸收的电流要小于许多应用中可控硅的维持电流。这样会产生调光范围受限和/或闪烁等不良情况。LED灯对线路和调光器形成相对较大的阻抗，加上LED驱动器无法衰减调光器和驱动器内通常用来提高EMI性能的LC网络的响应，就会出现很严重的振铃。这种效应会造成类似不良情况，因为振荡会使可控硅电流降至零并关断。

要克服这些问题，需增加无源衰减电路和无损耗的有源泄放电路。

电阻R24和R40用于在可控硅调光期间衰减输入网络。

额外的衰减通过在AC输入的前沿部分增大处理功率来提供。这种方法是在仿真无源RC泄放电路的行为，但不会产生相关的损耗和调光缺点。

4.5 空载/开路负载保护

输出电压通过主绕组与偏置绕组的匝数比在偏置绕组上进行检测。电压稳压器U2将强制BP引脚进入自动重新启动模式，以调整输出电压。分压器R25和R18设置检测阈值。当导通期间偏置绕组上的电压发生反向时，二极管D7可防止U2产生反向电流。R17用于限制流入U2的最大电流。



4.6 可选关断电路

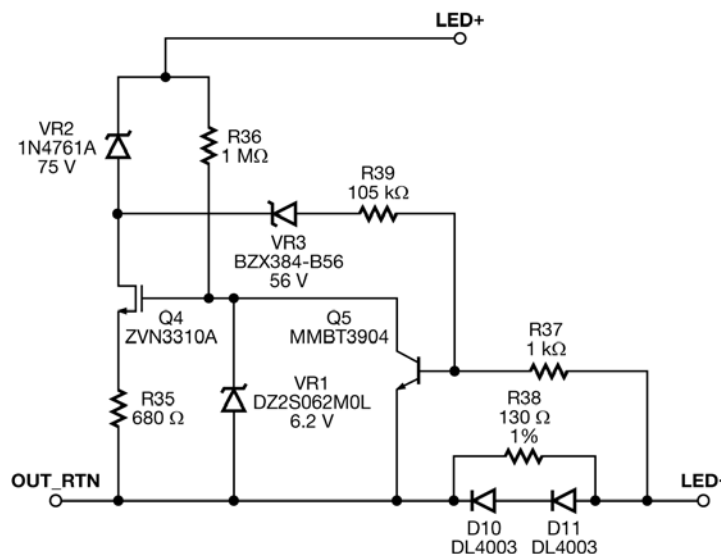

PI-7270-020614

Figure 4 – Turn-off Circuit.

在深度调光期间关断LED的有源假负载也集成在本设计中。当驱动器与导通角低于 30° 的调光器一起使用时，该关断电路用于避免输出光闪烁。当导通角 $\leq 30^\circ$ 时，调光器导通角更易于出现变化，因为存在线路噪声并且驱动器处理的功率将变得过低而无法维持电流。这可以导致在极低导通角下光输出出现闪烁。为避免此情况，当输出电流降至 $\sim 5\text{mA}$ 时，流入LED的输出电流终止。该输出电流阈值由电阻R38设置。如果R38上的电压降至 0.65V ($Q5_{V_{be}}$)以下，Q5将关断，Q4导通。Q4导通时，输出分流到VR2 + $Q4_{V_{DS}}$ + $\sim 4\text{V}$ 。此时，LED应关断并且所有输出电流转移到Q4分支。选用电阻R35使Q4分支吸收 $4\text{V}/R35$ 电流。该电流稍高于 5mA 阈值，以避免Q4分支和输出之间出现反弹。R35电压由 $Q4_{V_{GT}} - VR1$ 限制。这种配置还可限制Q4分支上的最大耗散。

二极管D10和D11用于将R38上的电压降限制到两个二极管压降，以提高效率并在输出短路时为R38提供保护。VR3和R39用于在开路负载时关断假负载。选用齐纳二极管VR3以使VR2 + VR3大于最大LED电压。电阻R36在Q5关断时对Q4进行偏置。

然而，输出电流可以处于 $< 1\text{mA}$ 的范围内。当调光器在最小调光器位置下启动时会发生这种情况。当假负载激活且吸收 $4\text{V}/R35$ 电流时会发生这种情况。应将衰减电路设计为不在 $I_{OUT} \text{ of } > 4\text{V}/R35$ 下闪烁，以免出现闪烁。

如果驱动器与在 230VAC 、 50Hz 频率下最小导通角为 45° 或更高的调光器一起使用，则可省去关断电路，用跳线电阻替换R38。



5 PCB布局

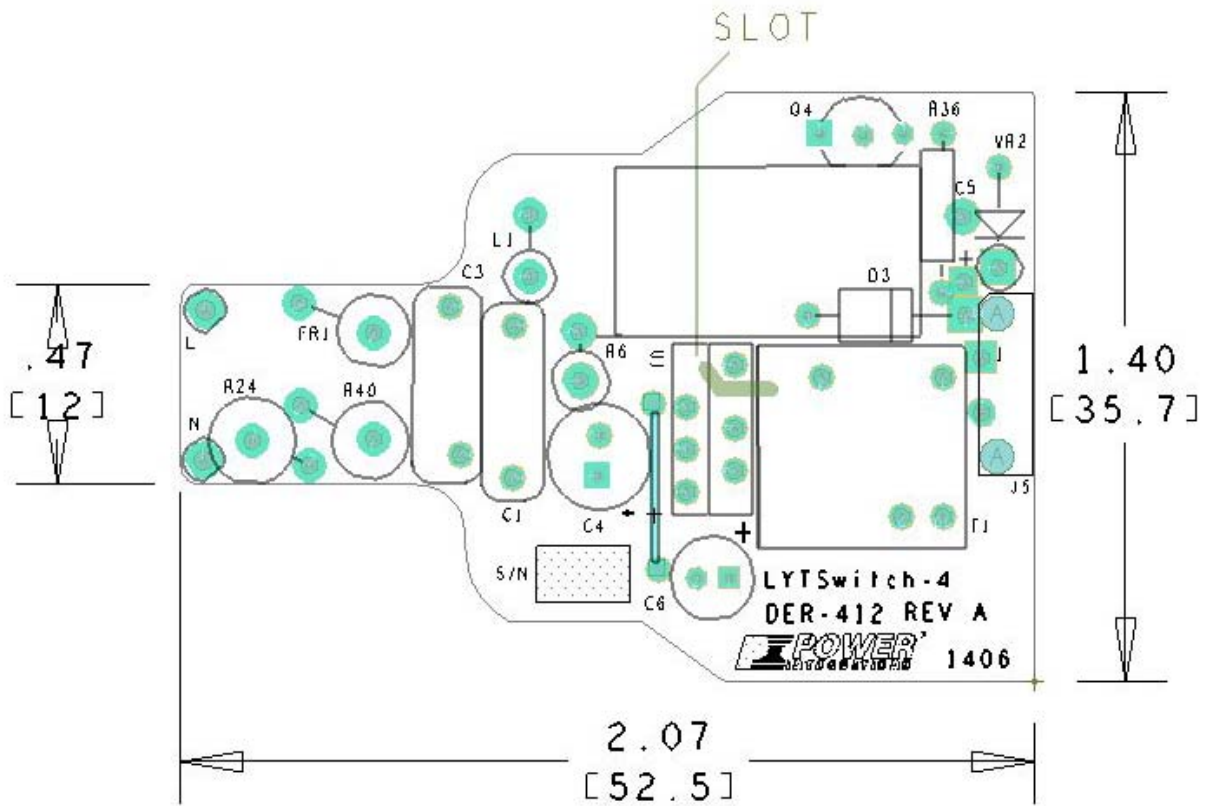

Figure 5 – Top Side.



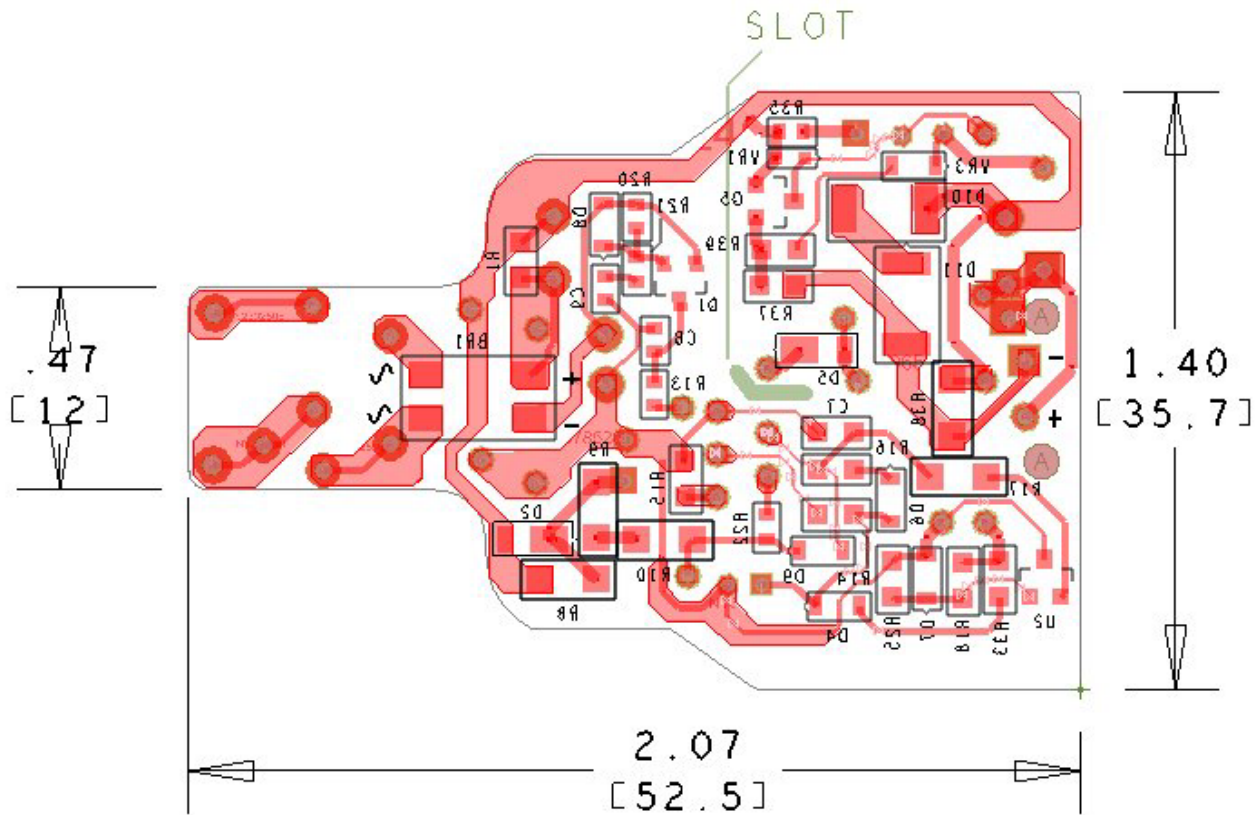

Figure 6 – Bottom Side.



6 物料清单(BOM)

6.1 不含关断电路的BOM

Item	Qty	Ref Des	Description	Mfg Part Number	Mfg
1	1	BR1	1000 V, 0.8 A, Bridge Rectifier, SMD, MBS-1, 4-SOIC	B10S-G	Comchip
2	1	C1	10 nF, 630 V, Film	ECQ-E6103KF	Panasonic
3	1	C3	220 nF, 450 V, Film	MEXXF32204JJ	Duratech
4	1	C4	2.2 μ F, 400 V, Electrolytic, (6.3 x 11)	TAB2GM2R2E110	Ltec
5	1	C5	56 μ F, 160 V, Electrolytic, Gen. Purpose, (10 x 20)	UCY2C560MPD1TD	Nichicon
6	1	C6	4.7 μ F, 50 V, Electrolytic, Gen. Purpose, (5 x 11)	EKMG500ELL4R7ME11D	Nippon Chemi-Con
7	1	C7	4.7 μ F, 10 V, Ceramic, X7R, 0805	CL21A475KBQNNNE	Samsung
8	1	C8	680 pF 100 V, Ceramic, NPO, 0603	CGA3E2C0G2A681J	TDK
9	1	C9	100 pF 50 V, Ceramic, NPO, 0603	CC0603JRNPO9BN101	Yageo
10	1	D2	600 V, 1 A, Rectifier, Glass Passivated, POWERDI123	DFLR1600-7	Diodes, Inc.
11	1	D3	600 V, 1 A, Ultrafast Recovery, DO-41	STTH1R06RL	ST Micro
12	1	D4	250 V, 0.2 A, Fast Switching, 50 ns, SOD-323	BAV21WS-7-F	Diodes, Inc.
13	1	D5	DIODE, UFAST, 200V, 1A, POWERDI123	DFLU1200-7	Diodes, Inc.
14	1	D6	75 V, 0.15 A, Switching, SOD-323	BAV16WS-7-F	Diodes, Inc.
15	1	D7	75 V, 0.15 A, Switching, SOD-323	BAV16WS-7-F	Diodes, Inc.
16	1	D8	75 V, 0.15 A, Switching, SOD-323	BAV16WS-7-F	Diodes, Inc.
17	1	D9	75 V, 0.15 A, Switching, SOD-323	BAV16WS-7-F	Diodes, Inc.
18	1	FR1	47 Ω , 5%, 2 W, Wirewound, Fusible	FW20A47R0JA	Bourns
19	1	R38	0 Ω , 5%, 1/4 W, Thick Film, 1206	ERJ-8GEY0R00V	Panasonic
20	1	L1	4.7 mH, 90 mA, 20 Ohm, RF Inductor	B82144A2475J	Epcos
21	1	Q1	NPN, Small Signal BJT, 40 V, 0.2 A, SOT-23	MMBT3904LT1G	On Semi
22	1	R1	10 k Ω , 5%, 1/8 W, Thick Film, 0805	ERJ-6GEYJ103V	Panasonic
23	1	R6	27 Ω , 5%, 1 W, Metal Oxide	RSF100JB-27R	Yageo
24	1	R8	510 k Ω , 5%, 1/4 W, Thick Film, 1206	ERJ-8GEYJ514V	Panasonic
25	1	R9	1.50 M Ω , 1%, 1/4 W, Thick Film, 1206	ERJ-8ENF1504V	Panasonic
26	1	R10	1.50 M Ω , 1%, 1/4 W, Thick Film, 1206	ERJ-8ENF1504V	Panasonic
27	1	R13	82 k Ω , 5%, 1/10 W, Thick Film, 0603	ERJ-3GEYJ823V	Panasonic
28	1	R14	137 k Ω , 1%, 1/8 W, Thick Film, 0805	ERJ-6ENF1373V	Panasonic
29	1	R15	24.9 k Ω , 1%, 1/8 W, Thick Film, 0805	ERJ-6ENF2492V	Panasonic
30	1	R16	6.2 k Ω , 5%, 1/8 W, Thick Film, 0805	ERJ-6GEYJ622V	Panasonic
31	1	R17	20 R, 5%, 1/4 W, Thick Film, 1206	ERJ-8GEYJ200V	Panasonic
32	1	R18	62 k Ω , 5%, 1/8 W, Thick Film, 0805	ERJ-6GEYJ623V	Panasonic
33	1	R20	100 k Ω , 5%, 1/10 W, Thick Film, 0603	ERJ-3GEYJ104V	Panasonic
34	1	R21	10 k Ω , 5%, 1/10 W, Thick Film, 0603	ERJ-3GEYJ103V	Panasonic
35	1	R22	191 k Ω , 1%, 1/16 W, Thick Film, 0603	ERJ-3EKF1913V	Panasonic
36	1	R24	200 Ω , 5%, 3 W, Metal Oxide	ERG-3SJ201	Panasonic
37	1	R25	5.1 k, 5%, 1/8 W, Thick Film, 0805	ERJ-6GEYJ512V	Panasonic
38	1	R33	10 Ω , 5%, 1/8 W, Thick Film, 0805	ERJ-6GEYJ100V	Panasonic
39	1	R40	200 Ω , 5%, 3 W, Metal Oxide	ERG-3SJ201	Panasonic
40	1	T1	Bobbin, EE13, Vertical, 10 pins Transformer Transformer	P-1302-2 SNX-R1731 POL-LYT030	Pin Shine Santronics Premier Magnetics
41	1	U1	LYTSwitch-4, eSIP-7C	LYT4322E	Power Integrations
42	1	U2	IC, REG ZENER SHUNT ADJ SOT-23	LM431AIM3/NOPB	National Semi



43	1	WIRE 24AWG	Wire, UL1007, #24AWG, Red, PVC, 3 in	1007-24/7-2	Anixter
44	1	WIRE 24AWG	Wire, UL1007, 24AWG, Blk, PVC, 3 in	1007-24/7-0	Anixter
45	1	WIRE 24AWG	Wire, UL1007, #24AWG, Blu, PVC, 3 in	1007-24/7-6	Anixter
46	1	WIRE 24AWG	Wire, UL1007, #24AWG, Wht, PVC, 3in	1007-24/7-9	Anixter

6.2 BOM With Turn-off Circuit

Item	Qty	Ref Des	Description	Mfg Part Number	Mfg
1	1	BR1	1000 V, 0.8 A, Bridge Rectifier, SMD, MBS-1, 4-SOIC	B10S-G	Comchip
2	1	C1	10 nF, 630 V, Film	ECQ-E6103KF	Panasonic
3	1	C3	220 nF, 450 V, Film	MEXXF32204JJ	Duratech
4	1	C4	2.2 μ F, 400 V, Electrolytic, (6.3 x 11)	TAB2GM2R2E110	Ltec
5	1	C5	56 μ F, 160 V, Electrolytic, Gen. Purpose, (10 x 20)	UCY2C560MPD1TD	Nichicon
6	1	C6	4.7 μ F, 50 V, Electrolytic, Gen. Purpose, (5 x 11)	EKMG500ELL4R7ME11D	Nippon Chemi-Con
7	1	C7	4.7 μ F, 10 V, Ceramic, X7R, 0805	CL21A475KBQNNNE	Samsung
8	1	C8	680 pF 100 V, Ceramic, NPO, 0603	CGA3E2C0G2A681J	TDK
9	1	C9	100 pF 50 V, Ceramic, NPO, 0603	CC0603JRNPO9BN101	Yageo
10	1	D2	600 V, 1 A, Rectifier, Glass Passivated, POWERDI123	DFLR1600-7	Diodes, Inc.
11	1	D3	600 V, 1 A, Ultrafast Recovery, DO-41	STTH1R06RL	ST Micro
12	1	D4	250 V, 0.2 A, Fast Switching, 50 ns, SOD-323	BAV21WS-7-F	Diodes, Inc.
13	1	D5	DIODE, UFAST, 200V, 1A, POWERDI123	DFLU1200-7	Diodes, Inc.
14	4	D6 D7 D8 D9	75 V, 0.15 A, Switching, SOD-323	BAV16WS-7-F	Diodes, Inc.
15	2	D10 D11	200 V, 1 A, Rectifier, Glass Passivated, DO-213AA (MELF)	DL4003-13-F	Diodes, Inc.
16	1	FR1	47 R, 5%, 2 W, Wirewound, Fusible	FW20A47R0JA	Bourns
17	1	L1	4.7 mH, 90 mA, 20 Ω , RF Inductor	B82144A2475J	Epcos
18	2	Q1 Q5	NPN, Small Signal BJT, 40 V, 0.2 A, SOT-23	MMBT3904LT1G	On Semi
19	1	Q4	100 V, 0.2 A, 10 Ω , N-Channel, TO-92	ZVN3310A	Diodes, Inc.
20	2	R1 R39	10 k Ω , 5%, 1/8 W, Thick Film, 0805	ERJ-6GEYJ103V	Panasonic
21	1	R6	27 Ω , 5%, 1 W, Metal Oxide	RSF100JB-27R	Yageo
22	1	R8	510 k Ω , 5%, 1/4 W, Thick Film, 1206	ERJ-8GEYJ514V	Panasonic
23	2	R9 R10	1.50 M Ω , 1%, 1/4 W, Thick Film, 1206	ERJ-8ENF1504V	Panasonic
24	1	R13	82 k Ω , 5%, 1/10 W, Thick Film, 0603	ERJ-3GEYJ823V	Panasonic
25	1	R14	137 k Ω , 1%, 1/8 W, Thick Film, 0805	ERJ-6ENF1373V	Panasonic
26	1	R15	24.9 k Ω , 1%, 1/8 W, Thick Film, 0805	ERJ-6ENF2492V	Panasonic
27	1	R16	6.2 k Ω , 5%, 1/8 W, Thick Film, 0805	ERJ-6GEYJ622V	Panasonic
28	1	R17	20 Ω , 5%, 1/4 W, Thick Film, 1206	ERJ-8GEYJ200V	Panasonic
29	1	R18	62 k Ω , 5%, 1/8 W, Thick Film, 0805	ERJ-6GEYJ623V	Panasonic
30	1	R20	100 k Ω , 5%, 1/10 W, Thick Film, 0603	ERJ-3GEYJ104V	Panasonic
31	1	R21	10 k Ω , 5%, 1/10 W, Thick Film, 0603	ERJ-3GEYJ103V	Panasonic
32	1	R22	191 k Ω , 1%, 1/16 W, Thick Film, 0603	ERJ-3EKF1913V	Panasonic
33	2	R24 R40	200 Ω , 5%, 3 W, Metal Oxide	ERG-3SJ201	Panasonic
34	1	R25	5.1 k Ω , 5%, 1/8 W, Thick Film, 0805	ERJ-6GEYJ512V	Panasonic



35	1	R33	10 Ω , 5%, 1/8 W, Thick Film, 0805	ERJ-6GEYJ100V	Panasonic
36	1	R35	680 Ω , 5%, 1/10 W, Thick Film, 0603	ERJ-3GEYJ681V	Panasonic
37	1	R36	1 M Ω , 5%, 1/4 W, Carbon Film	CFR-25JB-1M0	Yageo
38	1	R37	1 k Ω , 5%, 1/8 W, Thick Film, 0805	ERJ-6GEYJ102V	Panasonic
39	1	R38	130 Ω , 1%, 1/4 W, Thick Film, 1206	ERJ-8ENF1300V	Panasonic
40	1	T1	Bobbin, EE13, Vertical, 10 pins Transformer Transformer	P-1302-2 SNX-R1731 POL-LYT030	Pin Shine Santronics Premier Magnetics
41	1	U1	LYTSwitch-4, eSIP-7C	LYT4322E	Power Integrations
42	1	U2	IC, REG ZENER SHUNT ADJ SOT-23	LM431AIM3/NOPB	National Semi
43	1	VR1	6.2 V, 5%, 150 mW, SSMINI-2	DZ2S062M0L	Panasonic
44	1	VR2	75 V, 5%, 1 W, DO-41	1N4761A-TR	Vishay
45	1	VR3	56 V, 2%, 300 mW, SOD323	BZX384-B56,115	NXP Semi
46	1	WIRE 24AWG	Wire, UL1007, #24AWG, Red, PVC, 3 in	1007-24/7-2	Anixter
47	1	WIRE 24AWG	Wire, UL1007, #24AWG, Blk, PVC, 3 in	1007-24/7-0	Anixter
48	1	WIRE 24AWG	Wire, UL1007, #24AWG, Blu, PVC, 3 in	1007-24/7-6	Anixter
49	1	WIRE 24AWG	Wire, UL1007, #24AWG, Wht, PVC, 3 in	1007-24/7-9	Anixter



7 电感设计表格

ACDC_LYTSwitch-4_HL_012114; Rev.1.2; Copyright Power Integrations 2014	INPUT	INFO	OUTPUT	UNIT	LYTSwitch-4_HL_012114: Flyback Transformer Design Spreadsheet
ENTER APPLICATION VARIABLES					
Dimming required	YES		YES		Select 'YES' option if dimming is required. Otherwise select 'NO'.
VACMIN	190		190	V	Minimum AC Input Voltage
VACMAX			265	V	Maximum AC input voltage
fL			50	Hz	AC Mains Frequency
VO	120		120	V	Typical output voltage of LED string at full load
VO_MAX			132.00	V	Maximum expected LED string Voltage.
VO_MIN			108.00	V	Minimum expected LED string Voltage.
V_OVP			142.37	V	Over-voltage protection setpoint
IO	0.1		0.10	A	Typical full load LED current
PO			12.0	W	Output Power
n	0.85		0.85		Estimated efficiency of operation
VB			25	V	Bias Voltage
ENTER LYTSwitch VARIABLES					
LYTSwitch	LYT4322		LYT4322		Selected LYTSwitch
Current Limit Mode	FULL		FULL		Select "RED" for reduced Current Limit mode or "FULL" for Full current limit mode
ILIMITMIN			0.79	A	Minimum current limit
ILIMITMAX			0.92	A	Maximum current limit
fS			132000	Hz	Switching Frequency
fSmin			124000	Hz	Minimum Switching Frequency
fSmax			140000	Hz	Maximum Switching Frequency
IV			100.7	uA	V pin current
RV	3.2		3.2	M-ohms	Upper V pin resistor
RV2			1000000000000	M-ohms	Lower V pin resistor
IFB	177		177.0	uA	FB pin current (85 uA < IFB < 210 uA)
RFB1			124.3	k-ohms	FB pin resistor
VDS			10	V	LYTSwitch on-state Drain to Source Voltage
VD			0.50	V	Output Winding Diode Forward Voltage Drop (0.5 V for Schottky and 0.8 V for PN diode)
VDB			0.70	V	Bias Winding Diode Forward Voltage Drop
Key Design Parameters					
KP	1.18		1.18		Ripple to Peak Current Ratio (For PF > 0.9, 0.4 < KP < 0.9)
LP			960	uH	Primary Inductance
VOR	120.5		120.5	V	Reflected Output Voltage.
Expected IO (average)			0.10	A	Expected Average Output Current
KP_VNOM		Info	1.00		!!! Info. PF at high line may be less than 0.9. Decrease KP for higher PF
TON_MIN			1.84	us	Minimum on time at maximum AC input voltage
PCLAMP			0.09	W	Estimated dissipation in primary clamp



ENTER TRANSFORMER CORE/CONSTRUCTION VARIABLES					
Core Type	EE13		EE13		Select Core Size
Custom Core					Enter Custom core part number (if applicable)
AE			0.171	cm ²	Core Effective Cross Sectional Area
LE			3.02	cm	Core Effective Path Length
AL			1130	nH/T ²	Ungapped Core Effective Inductance
BW			7.4	mm	Bobbin Physical Winding Width
M			0	mm	Safety Margin Width (Half the Primary to Secondary Creepage Distance)
L	4		4		Number of Primary Layers
NS	150		150		Number of Secondary Turns
DC INPUT VOLTAGE PARAMETERS					
VMIN			269	V	Peak input voltage at VACMIN
VMAX			375	V	Peak input voltage at VACMAX
CURRENT WAVEFORM SHAPE PARAMETERS					
DMAX			0.28		Minimum duty cycle at peak of VACMIN
IAVG			0.07	A	Average Primary Current
IP			0.60	A	Peak Primary Current (calculated at minimum input voltage VACMIN)
IRMS			0.15	A	Primary RMS Current (calculated at minimum input voltage VACMIN)
TRANSFORMER PRIMARY DESIGN PARAMETERS					
LP			960	uH	Primary Inductance
LP_TOL			10		Tolerance of primary inductance
NP			150		Primary Winding Number of Turns
NB			32		Bias Winding Number of Turns
ALG			43	nH/T ²	Gapped Core Effective Inductance
BM			2256	Gauss	Maximum Flux Density at PO, VMIN (BM<3100)
BP			3444	Gauss	Peak Flux Density (BP<3700)
BAC			1128	Gauss	AC Flux Density for Core Loss Curves (0.5 X Peak to Peak)
ur			1588		Relative Permeability of Ungapped Core
LG			0.48	mm	Gap Length (Lg> 0.1 mm)
BWE			29.6	mm	Effective Bobbin Width
OD			0.20	mm	Maximum Primary Wire Diameter including insulation
INS			0.04	mm	Estimated Total Insulation Thickness (= 2 * film thickness)
DIA			0.16	mm	Bare conductor diameter
AWG			35	AWG	Primary Wire Gauge (Rounded to next smaller standard AWG value)
CM			32	Cmils	Bare conductor effective area in circular mils
CMA			210	Cmils/Amp	Primary Winding Current Capacity (200 < CMA < 600)
TRANSFORMER SECONDARY DESIGN PARAMETERS (SINGLE OUTPUT EQUIVALENT)					
Lumped parameters					
ISP			0.60	A	Peak Secondary Current
ISRMS			0.22	A	Secondary RMS Current
IRIPPLE			0.20	A	Output Capacitor RMS Ripple Current (based on Expected IO)
CMS			44	Cmils	Secondary Bare Conductor minimum circular mils
AWGS			33	AWG	Secondary Wire Gauge (Rounded up to next larger standard AWG value)
DIAS			0.18	mm	Secondary Minimum Bare Conductor



					Diameter
ODS			0.05	mm	Secondary Maximum Outside Diameter for Triple Insulated Wire
VOLTAGE STRESS PARAMETERS					
VDRAIN			620	V	Estimated Maximum Drain Voltage assuming maximum LED string voltage (Includes Effect of Leakage Inductance)
PIVS			517	V	Output Rectifier Maximum Peak Inverse Voltage (calculated at VOVP, excludes leakage inductance spike)
PIVB			110	V	Bias Rectifier Maximum Peak Inverse Voltage (calculated at VOVP, excludes leakage inductance spike)
FINE TUNING (Enter measured values from prototype)					
V pin Resistor Fine Tuning					
RV1			3.20	M-ohms	Upper V Pin Resistor Value
RV2			1000000000000	M-ohms	Lower V Pin Resistor Value
VAC1			115.0	V	Test Input Voltage Condition1
VAC2			230.0	V	Test Input Voltage Condition2
IO_VAC1			0.10	A	Measured Output Current at VAC1
IO_VAC2			0.10	A	Measured Output Current at VAC2
RV1 (new)			3.20	M-ohms	New RV1
RV2 (new)			16729.30	M-ohms	New RV2
V_OV			256.2	V	Typical AC input voltage at which OV shutdown will be triggered
V_UV			53.6	V	Typical AC input voltage beyond which power supply can startup
FB pin resistor Fine Tuning					
RFB1			124	k-ohms	Upper FB Pin Resistor Value
RFB2			1000000000000	k-ohms	Lower FB Pin Resistor Value
VB1			22.4	V	Test Bias Voltage Condition1
VB2			27.6	V	Test Bias Voltage Condition2
IO1			0.10	A	Measured Output Current at Vb1
IO2			0.10	A	Measured Output Current at Vb2
RFB1 (new)			124.3	k-ohms	New RFB1
RFB2(new)			1000000000000	k-ohms	New RFB2
Input Current Harmonic Analysis					
Harmonic			Max Current (mA)	Limit (mA)	
1st Harmonic			62.70	N/A	Fundamental (mA)
3rd Harmonic			16.03	48.00	PASS. 3rd Harmonic current content is lower than the limit
5th Harmonic			8.1	26.82	PASS. 5th Harmonic current content is lower than the limit
7th Harmonic			5.0	14.12	PASS. 7th Harmonic current content is lower than the limit
9th Harmonic			3.44	7.06	PASS. 9th Harmonic current content is lower than the limit
11th Harmonic			2.53	4.94	PASS. 11th Harmonic current content is lower than the limit
13th Harmonic			1.93	4.18	PASS. 13th Harmonic current content is lower than the limit
15th Harmonic			1.53	3.62	PASS. 15th Harmonic current content is lower than the limit
THD			29.6	%	Estimated total Harmonic Distortion (THD)



8 电感规格

8.1 电气原理图

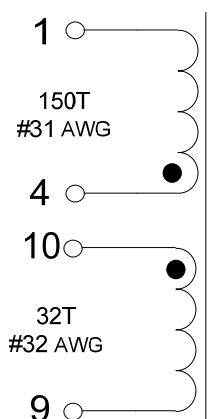

Figure 7 – Inductor Electrical Diagram.

8.2 电气规格

Primary Inductance	Pins 1-4, all other windings open, measured at 100kHz, 0.4 $V_{RMSAL} = 42.667 \text{ nH/n}^2$	960 $\mu\text{H} \pm 5\%$
---------------------------	---	---------------------------

8.3 材料

Item	Description
[1]	Core: EE13 NC2H or equivalent.
[2]	Bobbin:EE13;5/5 pinvertical.PI PN: 25-01023-00
[3]	Magnet Wire: #31 AWG.
[4]	Magnet Wire: #32 AWG.
[5]	Tape, Polyester film, 3M 1350F-1 or equivalent, 7.4 mm wide.
[6]	Dolph BC-359 or equivalent.



8.4 电感结构图

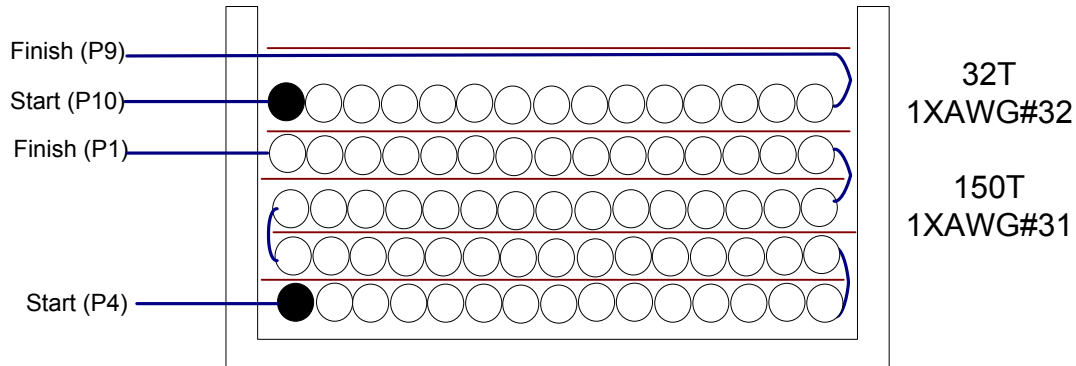

Figure 8 – Inductor Build Diagram.

8.5 电感构造

Bobbin Preparation	Place the bobbin item [2] on the mandrel with pin side on the left and winding direction is clockwise direction.
Winding1	Use wire item [3], start at pin 4 wind 150 turns in ~4 layers and at the last turn terminate the wire at pin 1. Apply 1 layer of tape item [5] between layers
Winding2	Use wire item [4], start at pin 10 wind 32 turns in ~1 layer, and at the last turn terminate the wire at pin 9. Apply 1 layer of tape item [5] between layers
Finish	Grind core to get 960μH inductance, secure the core with tape. Dip impregnate using varnish item[6]
Pins	Cut pins 2, 3, 5, 6, 7, 8.

9 性能数据

All measurements performed at room temperature using an LED load. The following data were measured using customer LED load of ~120V output voltage. Refer to the table on Section 9.4 for the complete set of test data values.

9.1 效率

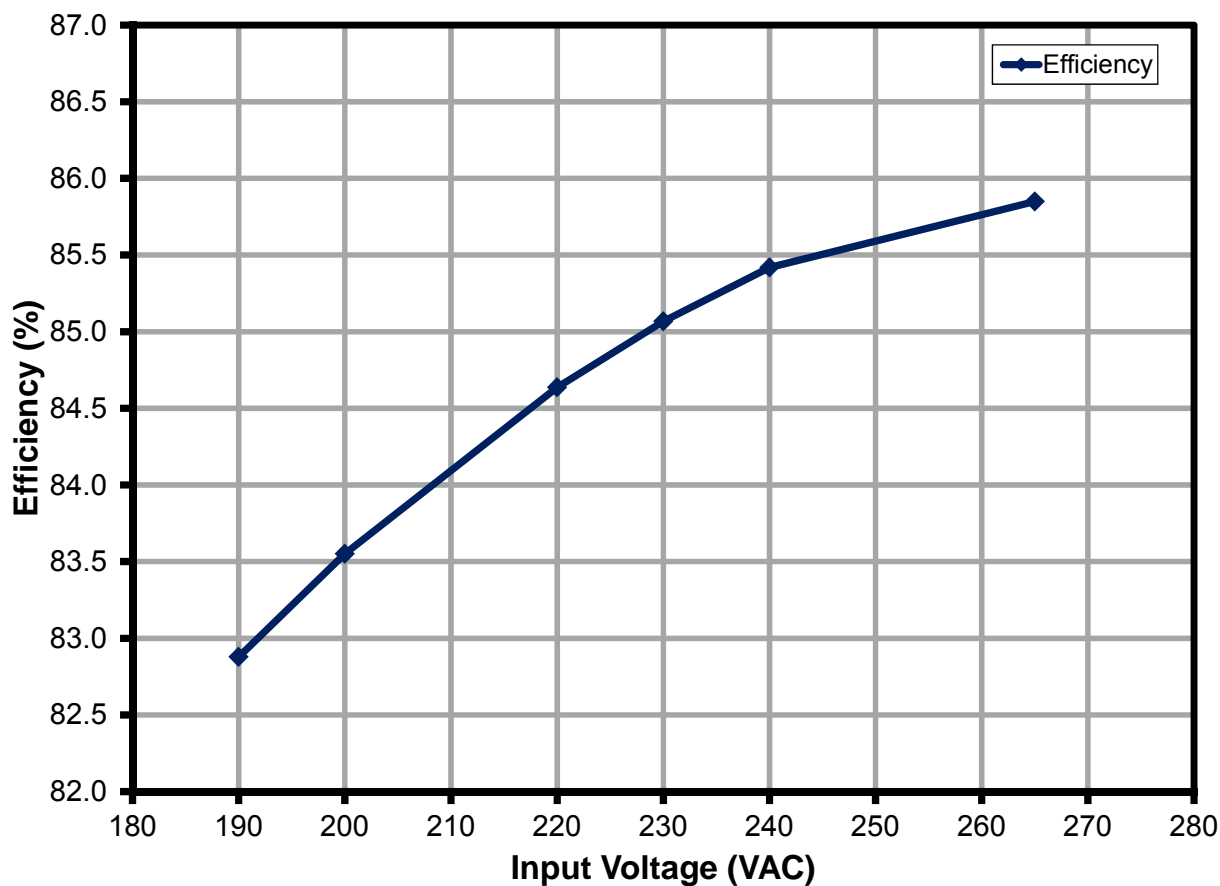

Figure 9 – Efficiency vs. Line.



9.2 线电压调整

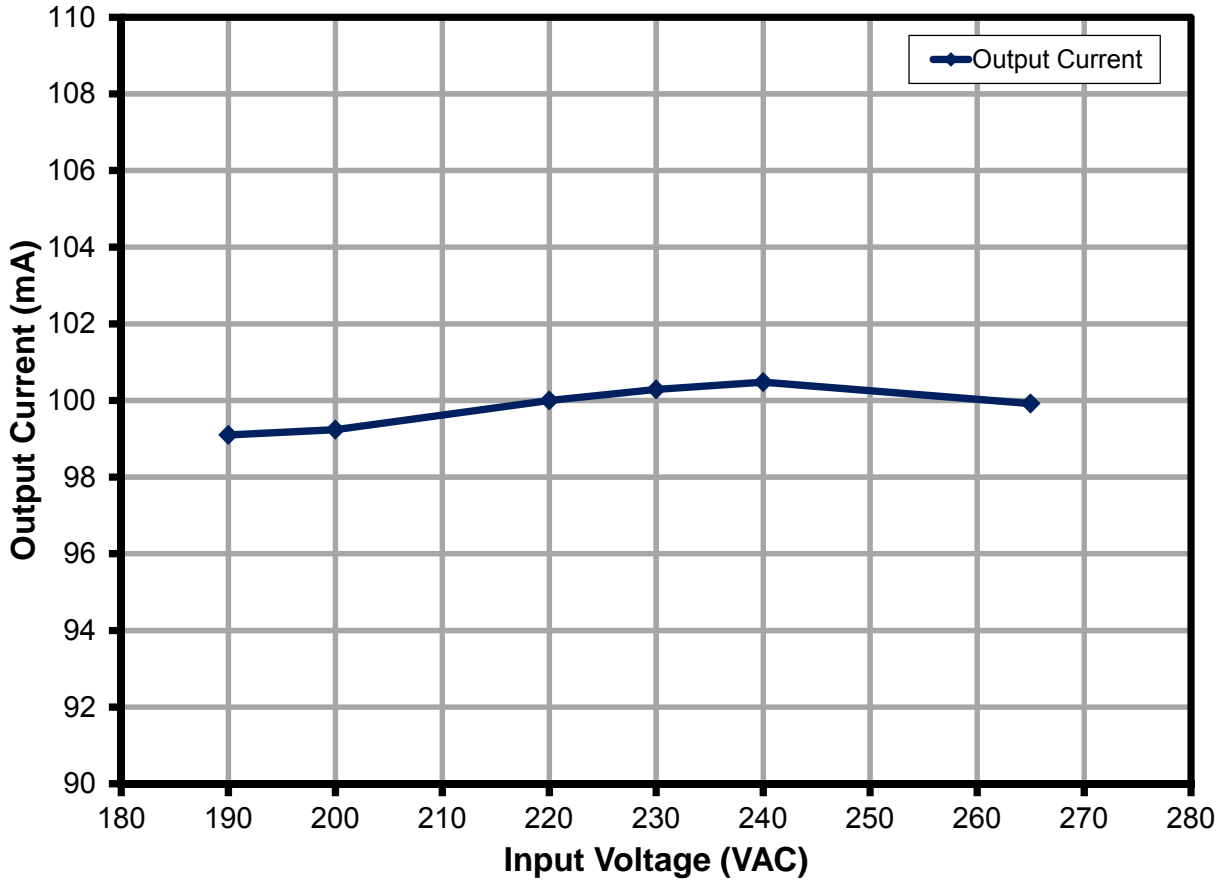

Figure 10 – Regulation vs. Line.



9.3 功率因数

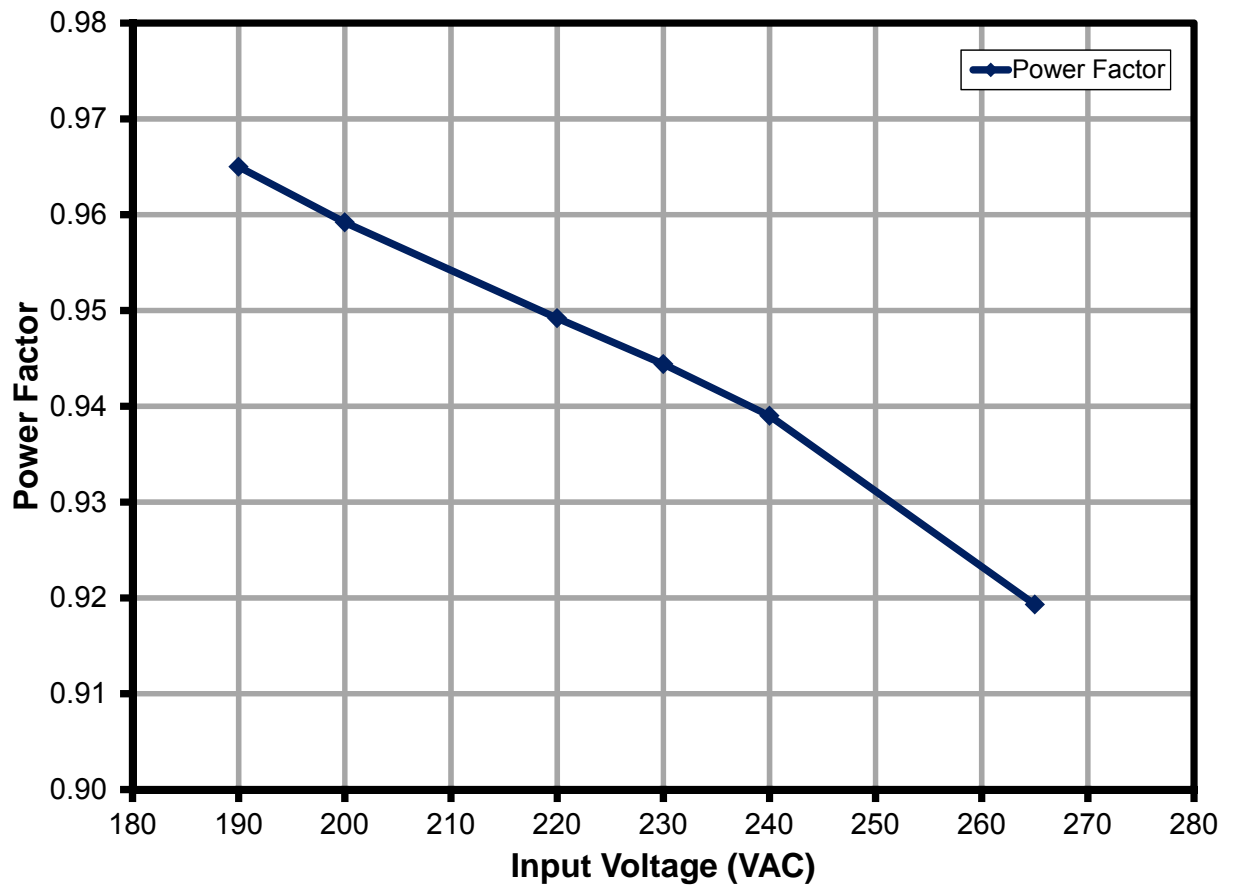

Figure 11 – Power Factor vs. Line.



9.4 测试数据

All measurements were taken with the board at open frame, 25 °C ambient, 50Hz line frequency, and customer supplied LED load

Input Measurement					Load Measurement			Calculation		
V _{IN} (V _{RMS})	I _{IN} (mA _{RMS})	P _{IN} (W)	PF	%ATHD	V _{OUT} (V _{DC})	I _{OUT} (mA _{DC})	P _{OUT} (W)	P _{CAL} (W)	Efficiency (%)	Loss (W)
190.11	76.22	13.983	0.965	22.45	116.7400	99.100	11.589	11.57	82.88	2.39
200.08	72.16	13.849	0.959	23.58	116.3900	99.240	11.571	11.55	83.55	2.28
220.11	65.86	13.760	0.949	24.43	116.2500	100.000	11.646	11.63	84.64	2.11
230.16	63.10	13.715	0.944	24.31	116.1300	100.290	11.667	11.65	85.07	2.05
240.13	60.65	13.675	0.939	24.05	116.0400	100.480	11.681	11.66	85.42	1.99
265.15	55.44	13.512	0.919	24.63	115.9000	99.920	11.600	11.58	85.85	1.91



10 调光性能数据

TRIAC dimming results were taken with input voltage of 230VAC, 60Hz line frequency, room temperature, and nominal ~120V LED load.

10.1 调光曲线

Taken using a programmable AC source providing the leading edge chopped AC input.

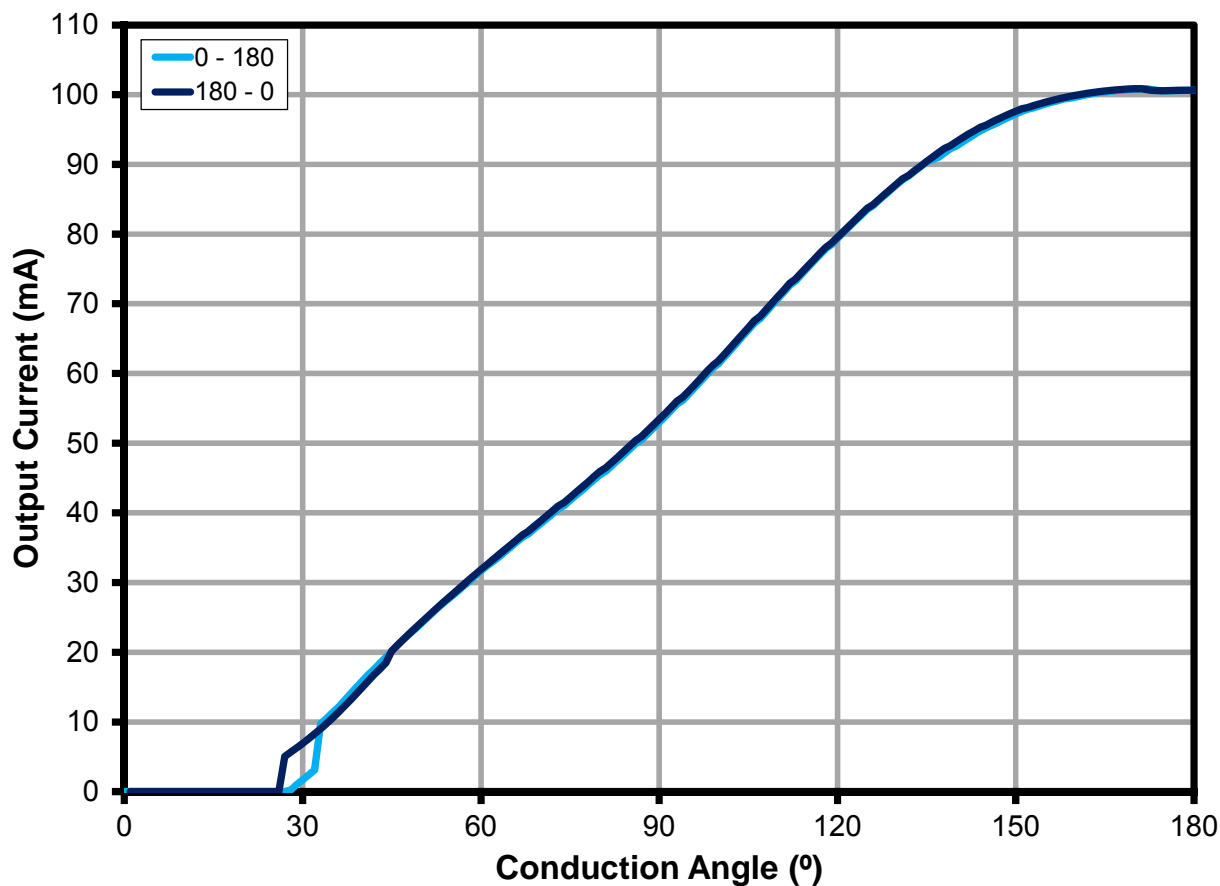

Figure 12 – Leading Edge Dimming Characteristics.



10.2 调光效率

Measured using a programmable AC source providing the leading edge chopped AC input. Note that dimming efficiency varies with the dimmer used.

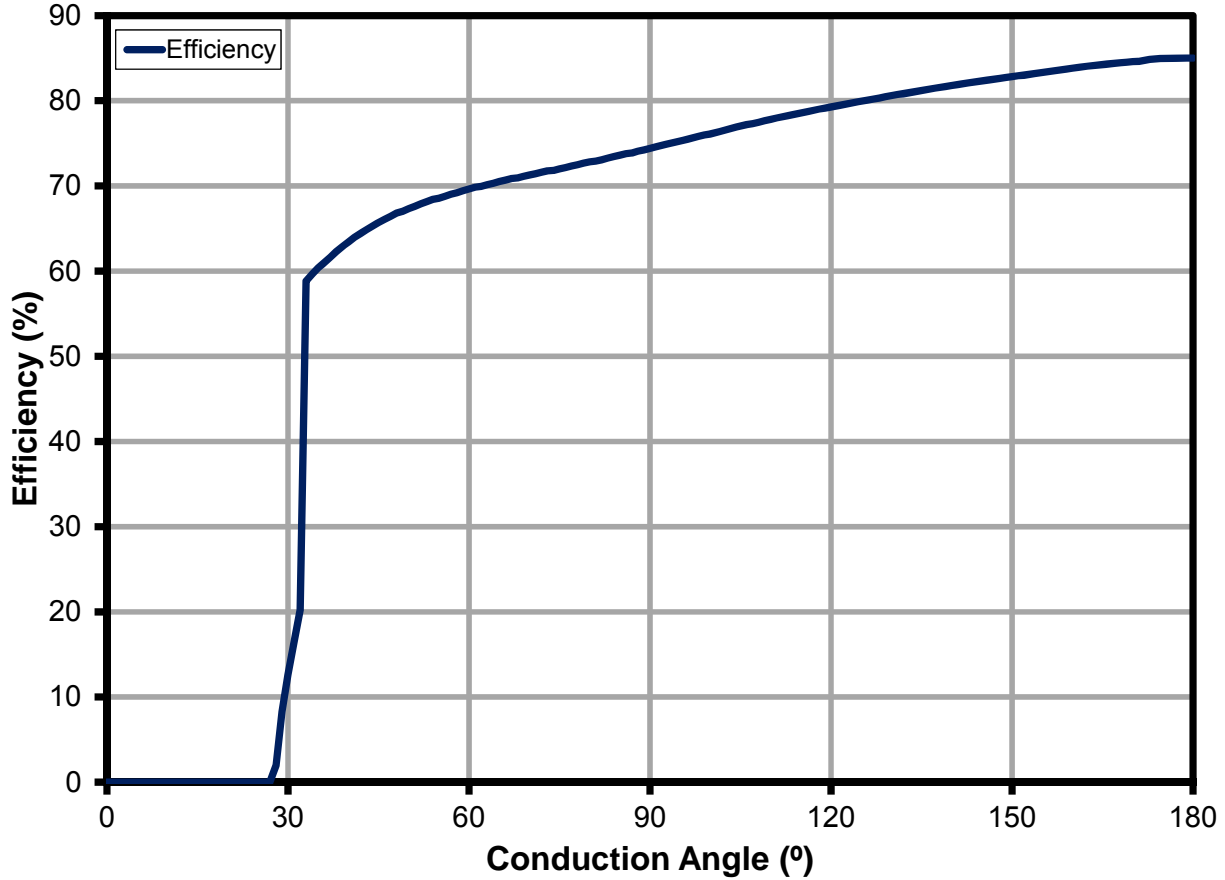

Figure 13 – Driver Efficiency as a function of Conduction Angle.

10.3 调光期间的驱动器功耗

Measured using a programmable AC source providing the leading edge chopped AC input. Note the increase in power loss at ~30 due to turn-off circuit.

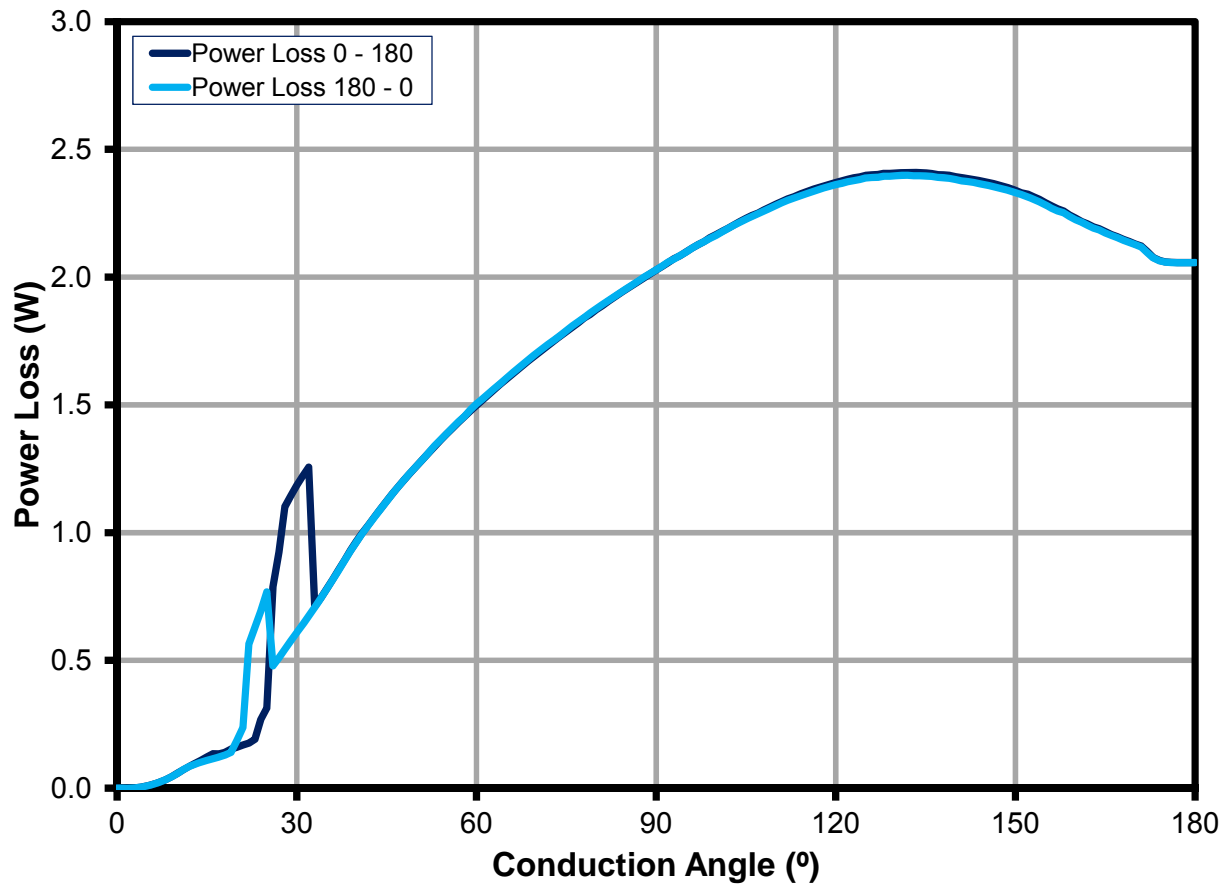

Figure 14 – Driver Power Loss as a function of Conduction Angle.



10.4 调光器兼容性列表

The unit was tested with the following high-linedimmers at 230VAC, 50 Hz input and ~120V LED load.

Dimmers	Type	I _{OUT} (mA)		DR
		Max	Min	
BERKER 2830 10	LE	97	28	3.46
JUNG 225 NV DE	LE	95	19	5.00
JUNG 254 UDIE 1	TE	95	20	4.75
JUNG 266 G DE	LE	97	23	4.22
BUSCH 2200 UJ-212	LE	97	33	2.94
BUSCH 2250 U	LE	98	19	5.16
BUSCH 2247 U	LE	97	28	3.46
GIRA 2262 00 / IO1	LE	97	15	6.47
GIRA 0300 00 / IO1	LE	97	32	3.03
GIRA 0302 00 / IO1	LE	98	24	4.08
GIRA 1176 00/IO3	TE	95	26	3.65
310-013	LE	99	27.5	3.60
310-017	TE	92	29	3.17
310-014	LE	99	33	3.00
310-016	LE	99	30	3.30
KOPP 8033	LE	93	25	3.72
BUSCH 691 U-101	ELEC	92	21	4.38
BUSCH 6513 U-102	TE	97	22	4.41
PEHA 433HAB	TE	93	31	3.00
PEHA 433HAB Oa	TE	86	21	4.10
REV 300W	LE	97	1	97.00
2250	LE	98	21	4.67
400W	LE	93	6	15.50
572499	LE	99	16	6.19
6513	TE	97	23	4.22
2875	LE	97	23	4.22
TCL	LE	100	21	4.76
SEN BO LANG	LE	100	35	2.86
EBA HUANG	LE	100	1	100.00
SB ELECT	LE	99	1	99.00
MYONGBO	LE	100	34	2.94
KBE	LE	100	5	20.00
CLIPMEI	LE	100	22	4.55
MANK	LE	100	37	2.70
32E450LM	LE	94	22	4.27
32E450TM	TE	92	20	4.60
32E2CFLDM	TE	91	20	4.55
32E450UDM	TE	95	24	3.96
SED200LRS	LE	99	1	99.0
WDE200L-1	LE	99	1	99.0
SED300FHS	LE	97	6	16.2
EED100PRS	LE	99	1	99.0
E0902 DIM	LE	97	17	5.7
WDE300F-1	LE	99	1	99.0



11 热性能

The following reading were taken at open frame, room temperature condition

11.1 230VAC, 50Hz: 未连接调光器

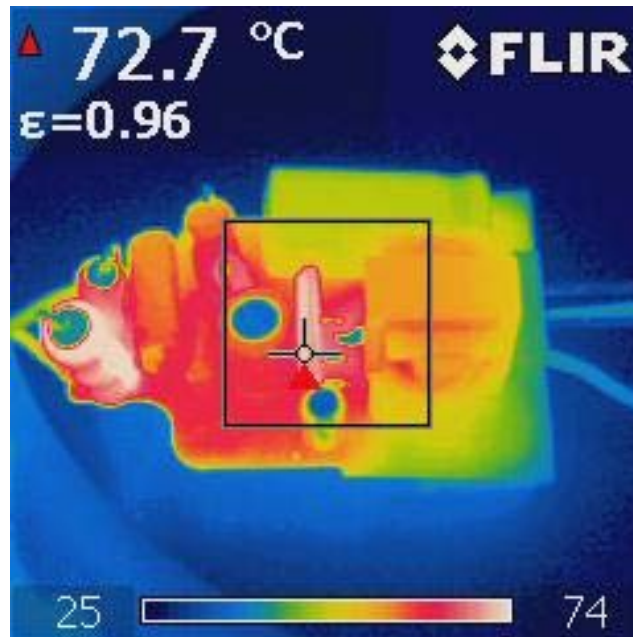

Figure 15 – U1: LYT4322E.

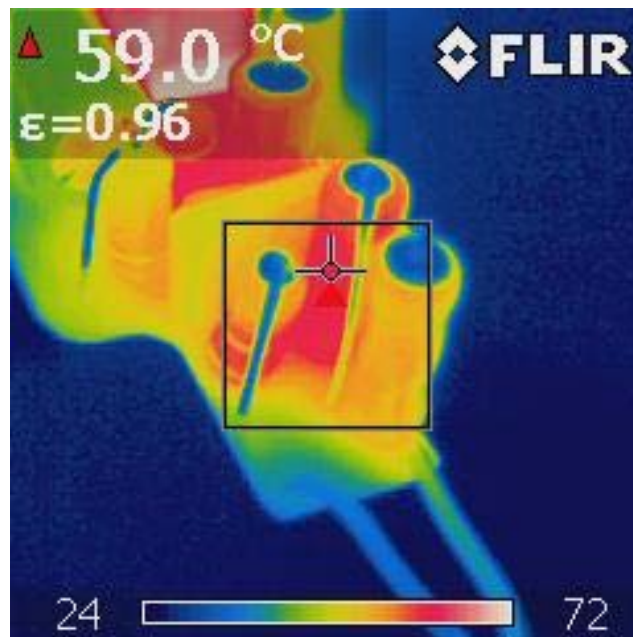

Figure 16 – R24: Damper Resistor.



11.2 230VAC, 50Hz: 连接调光器, 90°导通角

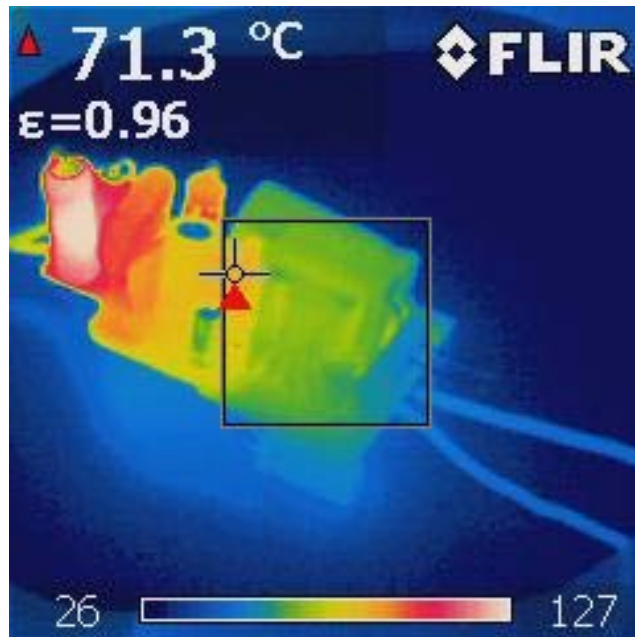

Figure 17 – U1:LYT4322E.

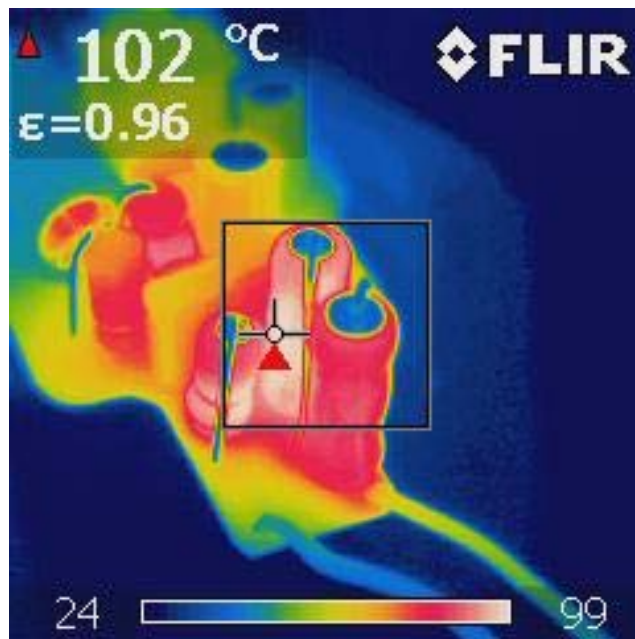

Figure 18 – R24: Damper Resistor.



12 非调光（未连接调光器）波形

12.1 输入电压和输入电流波形

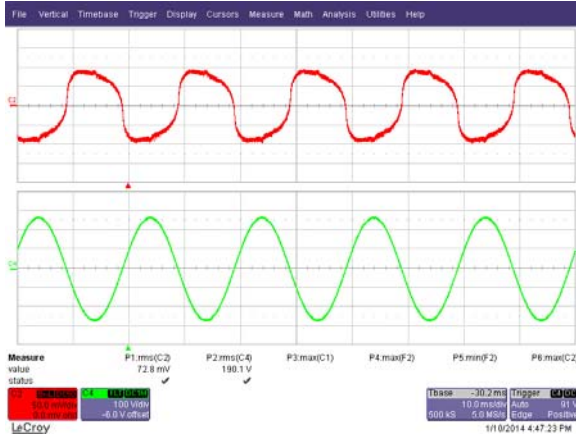

Figure 19 – 190 VAC, Full Load.
Upper: I_{IN} , 50mA / div.
Lower: V_{IN} , 100 V, 10 ms / div.

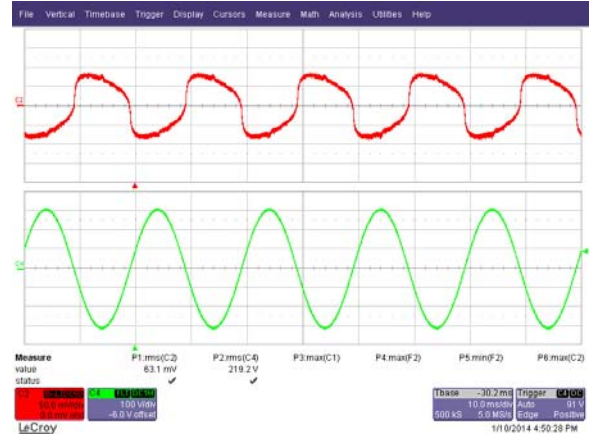

Figure 20 – 220 VAC, Full Load.
Upper: I_{IN} , 50mA / div.
Lower: V_{IN} , 100 V, 10 ms / div.

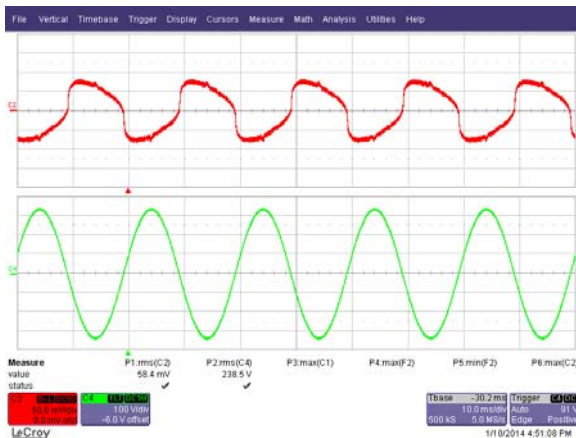

Figure 21 – 240 VAC, Full Load.
Upper: I_{IN} , 50mA / div.
Lower: V_{IN} , 100 V, 10 ms / div.

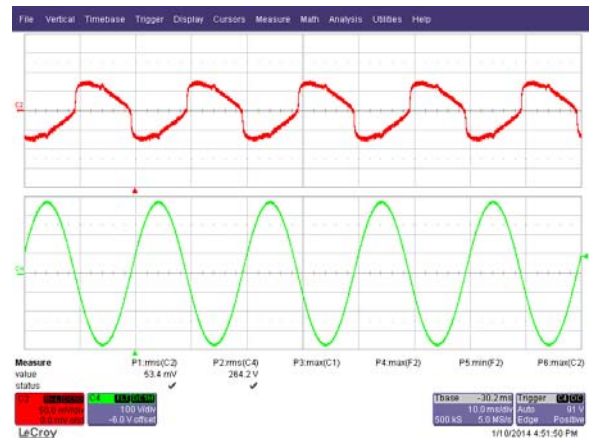

Figure 22 – 265 VAC, Full Load.
Upper: I_{IN} , 50mA / div.
Lower: V_{IN} , 100 V, 10 ms / div.



12.2 正常工作时的输出电流和输出电压

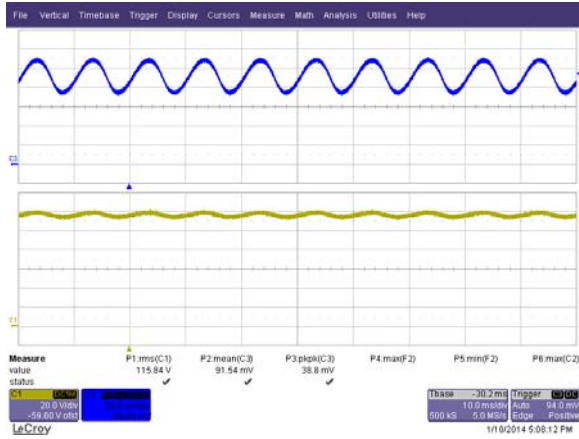

Figure 23 – 190 VAC, 50Hz. Full Load.
Upper: I_{OUT} , 20mA / div.
Lower: V_{OUT} , 20 V, 10 ms / div.

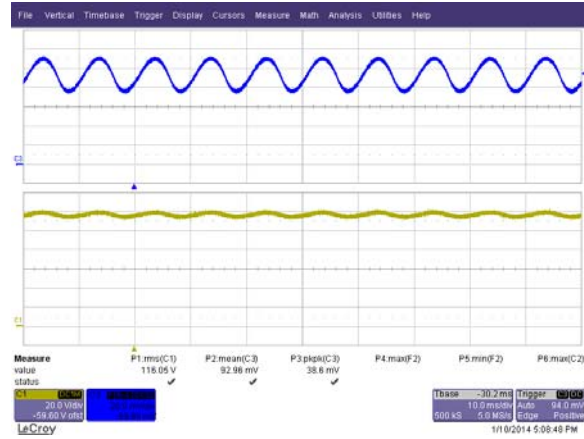

Figure 24 – 220 VAC, 50Hz. Full Load.
Upper: I_{OUT} , 20mA / div.
Lower: V_{OUT} , 20 V, 10 ms / div.

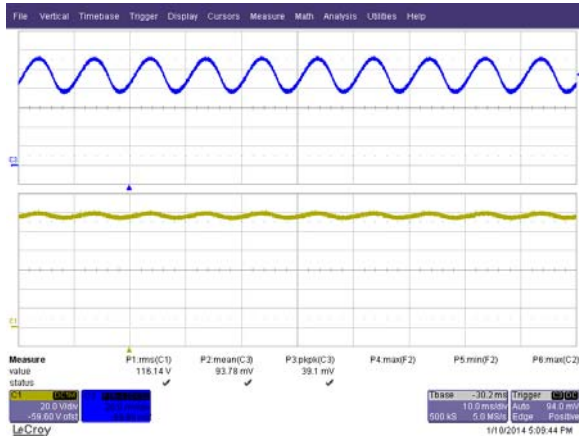

Figure 25 – 240 VAC, 50Hz. Full Load.
Upper: I_{OUT} , 20mA / div.
Lower: V_{OUT} , 20 V, 10 ms / div.

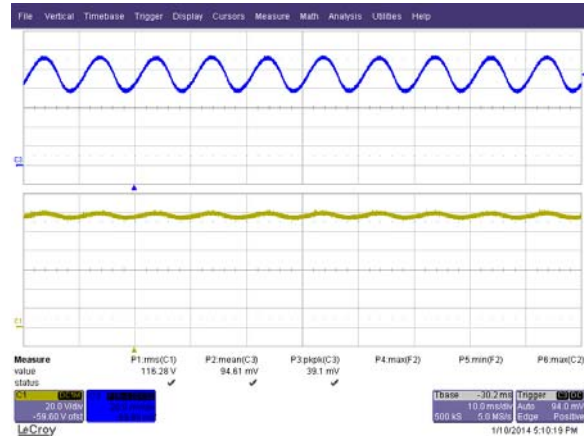

Figure 26 – 265 VAC, 50Hz. Full Load.
Upper: I_{OUT} , 20mA / div.
Lower: V_{OUT} , 20 V, 10 ms / div.

12.3 输出电流的升降

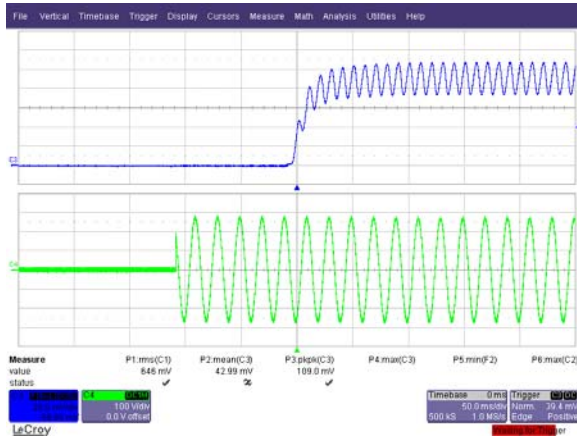

Figure 27 – 190 VAC Output Rise.
Upper: I_{OUT} , 20mA / div.
Lower: V_{IN} , 100 V, 50 ms / div.

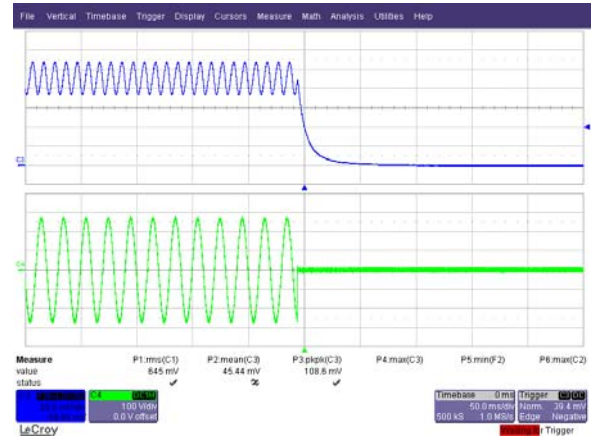

Figure 28 – 90 VAC Output Fall.
Upper: I_{OUT} , 20mA / div.
Lower: V_{IN} , 200 V, 100 ms / div.

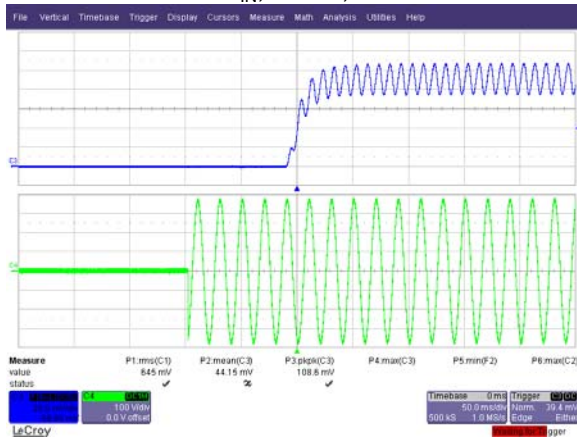

Figure 29 – 265 VAC Output Rise.
Upper: I_{OUT} , 20mA / div.
Lower: V_{IN} , 100 V, 50 ms / div.

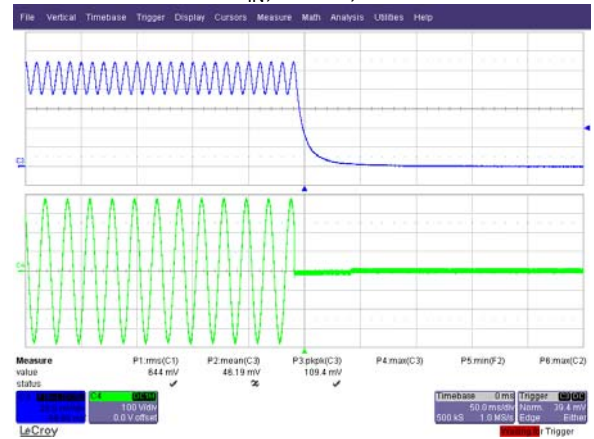

Figure 30 – 265 VAC Output Fall.
Upper: I_{OUT} , 20mA / div.
Lower: V_{IN} , 100 V, 50 ms / div.



12.4 正常工作时的漏极电压和电流

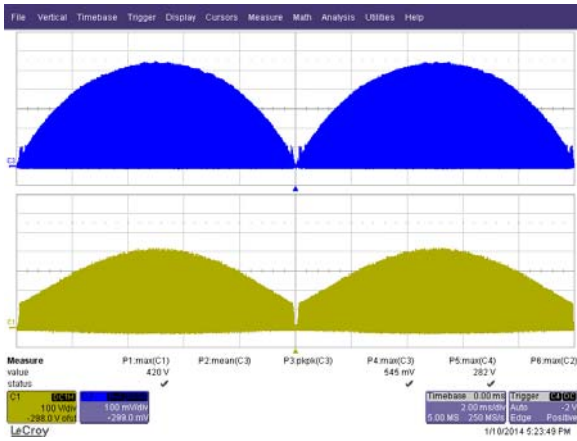

Figure 31 – 190 VAC, 50Hz.
Upper: I_{DRAIN} , 0.1 A / div.
Lower: V_{DRAIN} , 100 V, 2ms / div.

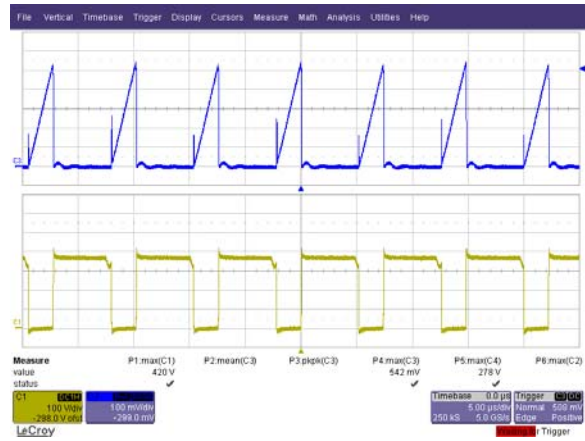

Figure 32 – 190 VAC, 50Hz.
Upper: I_{DRAIN} , 0.1 A / div.
Lower: V_{DRAIN} , 100 V / div., 5 μ s / div.

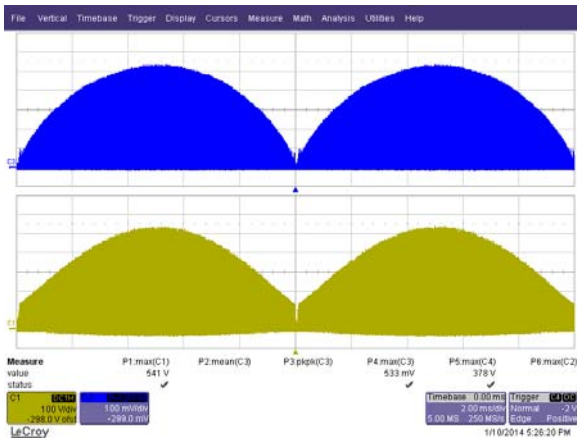

Figure 33 – 265 VAC, 50Hz.
Upper: I_{DRAIN} , 0.1 A / div.
Lower: V_{DRAIN} , 100 V, 2ms / div.

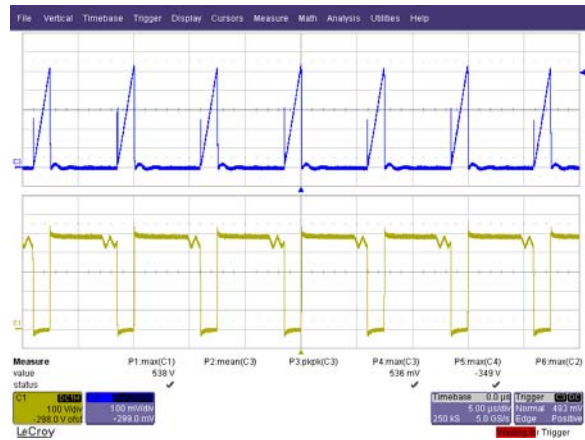

Figure 34 – 265 VAC, 50Hz.
Upper: I_{DRAIN} , 0.1 A / div.
Lower: V_{DRAIN} , 100 V / div., 5 μ s / div.

12.5 启动时的漏极电压和电流

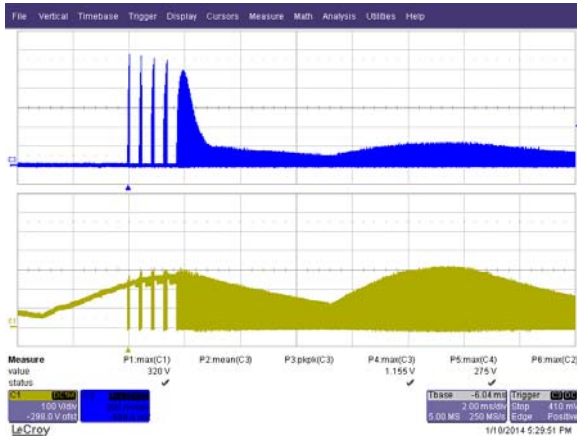

Figure 35 – 190 VAC, 50Hz Start-up.
Upper: I_{DRAIN} , 200mA / div.
Lower: V_{DRAIN} , 100 V, 2 ms / div.

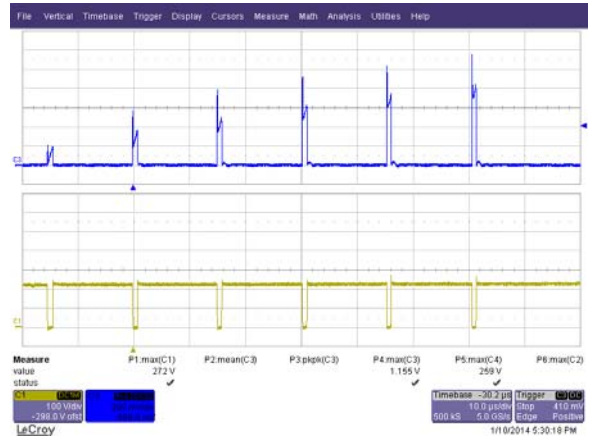

Figure 36 – 190 VAC, 50Hz Start-up.
Upper: I_{DRAIN} , 200mA / div.
Lower: V_{DRAIN} , 100 V, 10 μ s / div.

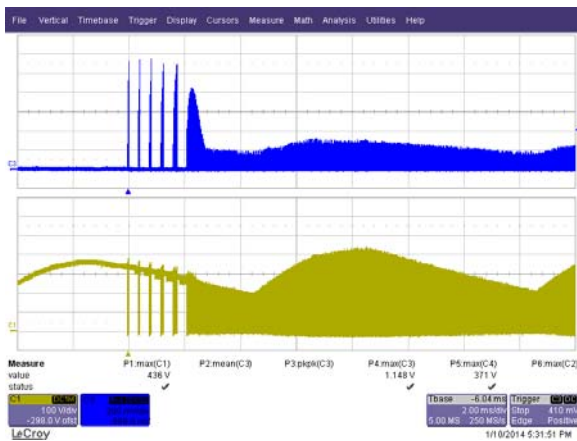

Figure 37 – 265 VAC, 50 Hz Start-up.
Upper: I_{DRAIN} , 200mA / div.
Lower: V_{DRAIN} , 100 V, 2 ms / div.

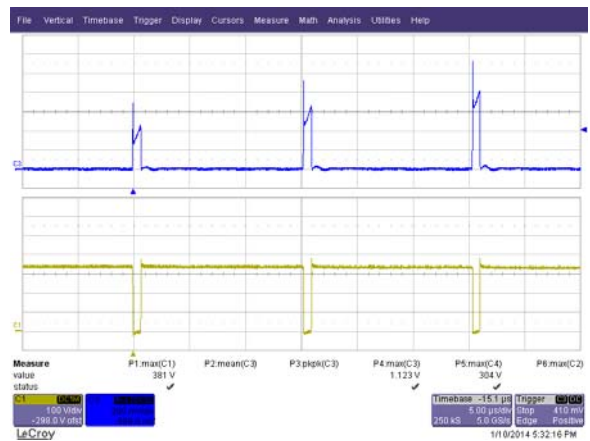

Figure 38 – 265 VAC, 50 Hz Start-up.
Upper: I_{DRAIN} , 200mA / div.
Lower: V_{DRAIN} , 100 V, 5 μ s / div.



12.6 输出短路时的漏极电流和漏极电压

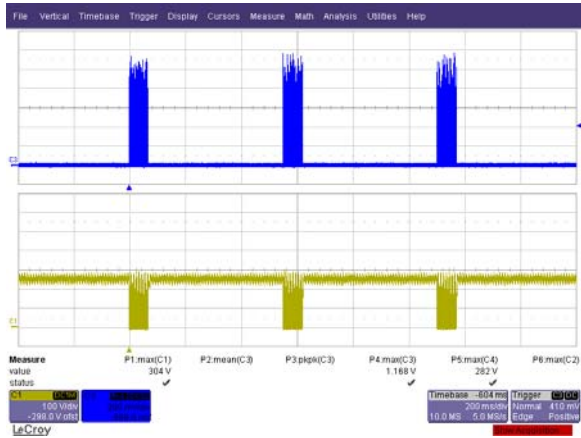

Figure 39 –190 VAC, 50Hz Output Short Condition.
Upper: I_{DRAIN} , 200mA / div.
Lower: V_{DRAIN} , 100 V, 200ms / div.

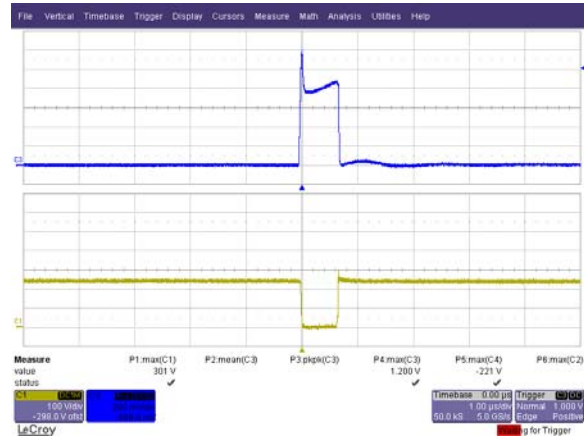

Figure 40 –190 VAC, 50Hz Output Short Condition.
Upper: I_{DRAIN} , 200 mA / div.
Lower: V_{DRAIN} , 100 V, 1 μ s / div.

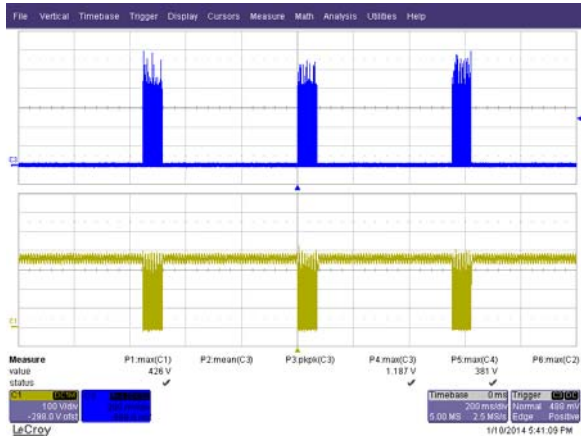

Figure 41 – 265 VAC, 50Hz Output Short Condition.
Upper: I_{DRAIN} , 200 mA / div.
Lower: V_{DRAIN} , 100 V, 5ms / div.

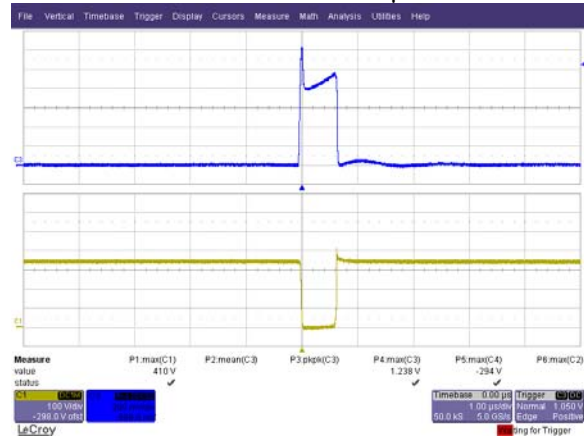

Figure 42 – 265 VAC, 50Hz Output Short Condition.
Upper: I_{DRAIN} , 200 mA / div.
Lower: V_{DRAIN} , 100 V, 1 μ s / div.

12.7 开路负载特性

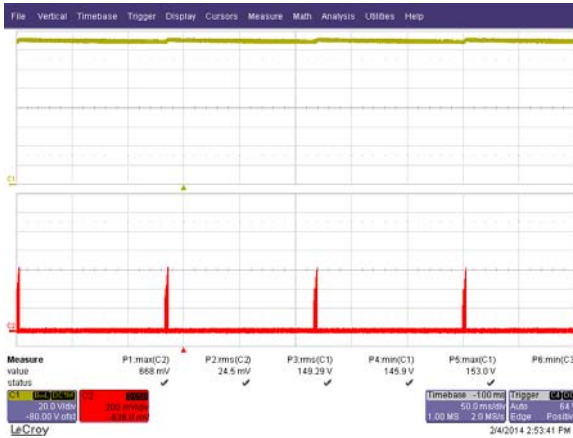

Figure 43 –190 VAC, 50Hz Open Load Condition.
Upper: V_{OUT} , 50 V / div.
Lower: I_{DRAIN} , 200 mA, 100ms / div.

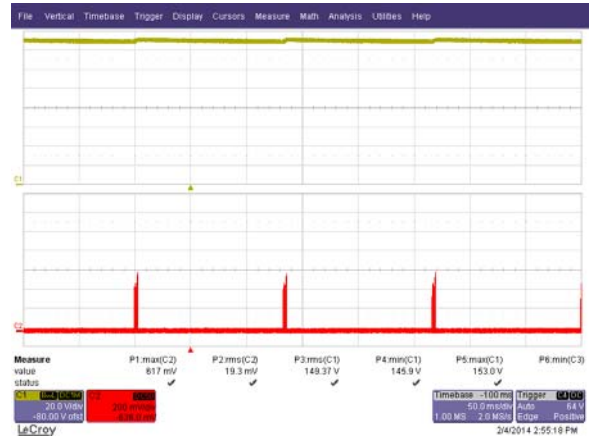

Figure 44 – 265 VAC, 50Hz Output Short Condition.
Upper: V_{OUT} , 50 V / div.
Lower: I_{DRAIN} , 200 mA, 200ms / div.

12.8 电压跌落/缓升

No failure of any component during brownout test of 0.5 V / sec AC cut-in and cut-off.

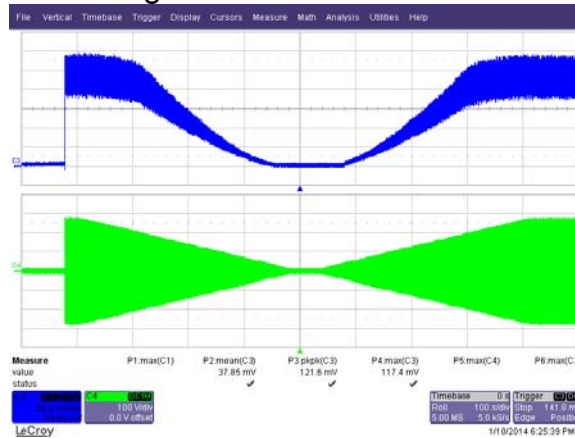

Figure 45 – Brown-out Test at 0.5V/ s. The Unit is Able to Operate Normally Without Any Failure and Without Flicker.Ch4: V_{IN} ; 100V/ div.
Ch2: I_{OUT} ; 20mA/ div.
Time Scale:100s/ div.



13 调光波形

13.1 输入电压及输入电流波形 - 前沿调光器

Input: 230VAC, 50Hz
 Output: 120V LED Load
 Dimmer: WDE300F-1

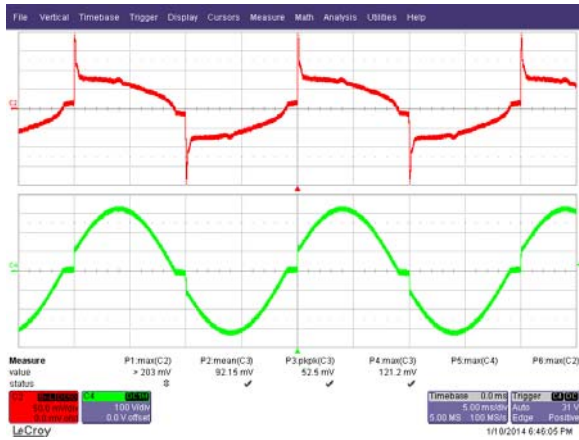

Figure 46 – 162° Conduction Angle.
 Upper: I_{IN} , 50mA / div.
 Lower: V_{IN} , 100 V, 5 ms / div.

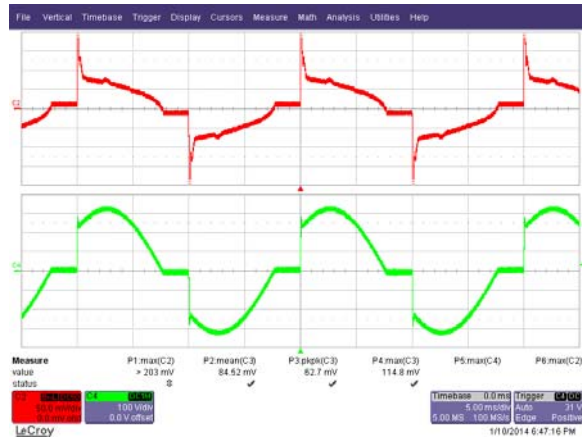

Figure 47 – 135° Conduction Angle.
 Upper: I_{IN} , 50mA / div.
 Lower: V_{IN} , 100 V, 5 ms / div.

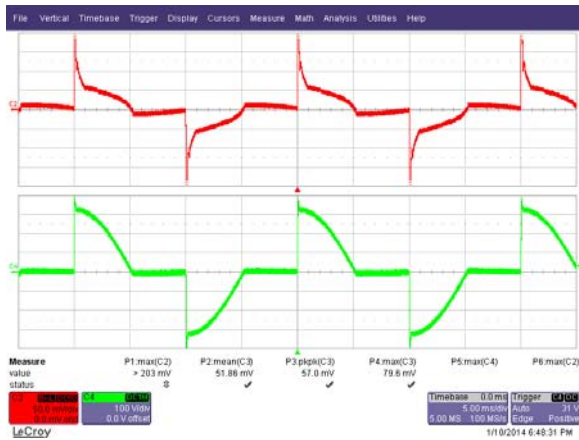

Figure 48 – 90° Conduction Angle.
 Upper: I_{IN} , 50mA / div.
 Lower: V_{IN} , 100 V, 5 ms / div.

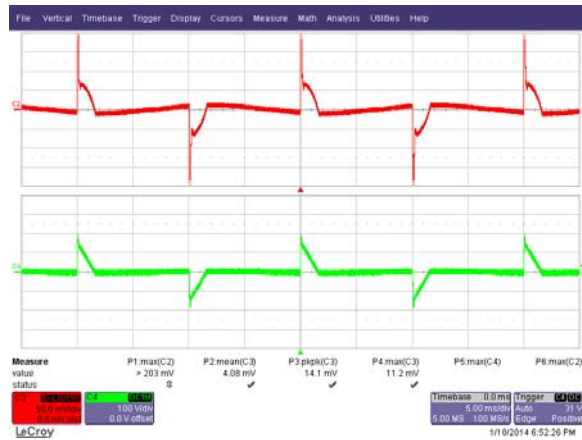

Figure 49 – 30° Conduction Angle.
 Upper: I_{IN} , 50mA / div.
 Lower: V_{IN} , 100 V, 5 ms / div.

13.2 输出电流波形 – 前沿调光器

Input: 230VAC, 50 Hz

Output: 120 V LED Load

Dimmer: WDE300F-1

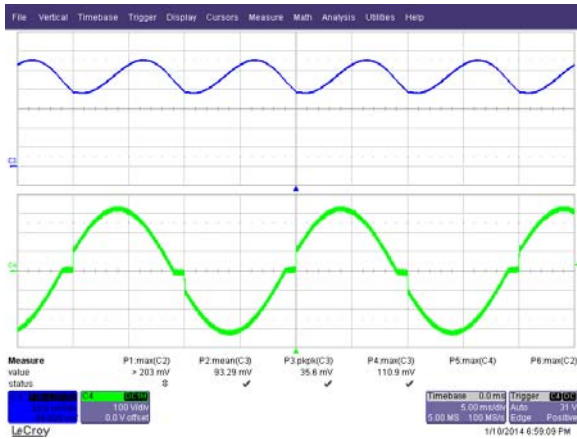

Figure 50 – 162° Conduction Angle.
Upper: I_{OUT} , 20mA / div.
Lower: V_{IN} , 100 V, 5 ms / div.

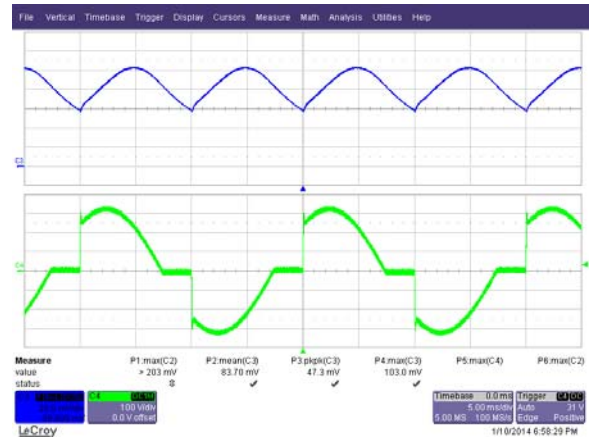

Figure 51 – 135° Conduction Angle.
Upper: I_{OUT} , 20mA / div.
Lower: V_{IN} , 100 V, 5 ms / div.

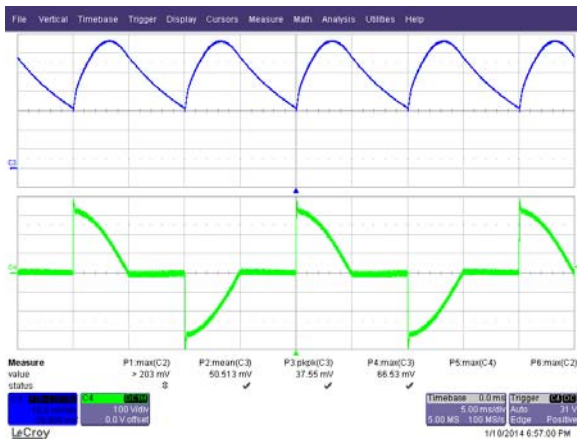

Figure 52 – 90° Conduction Angle.
Upper: I_{OUT} , 10mA / div.
Lower: V_{IN} , 100 V, 5 ms / div.

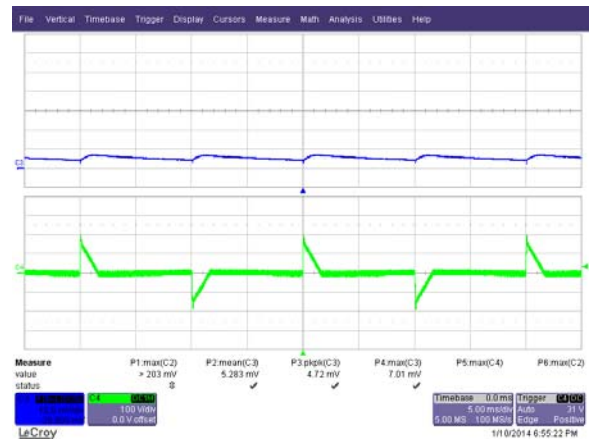

Figure 53 – 30° Conduction Angle.
Upper: I_{OUT} , 10mA / div.
Lower: V_{IN} , 100 V, 5 ms / div.



13.3 输入电压及输入电流波形 – 后沿调光器

Input: 230VAC, 50 Hz
 Output: 120 V LED Load
 Dimmer: PEHA 433HAB

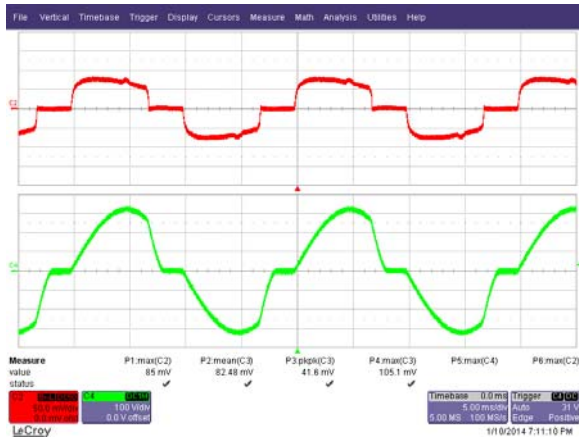

Figure 54 – 124°Conduction Angle.
 Upper: I_{IN} , 50mA / div.
 Lower: V_{IN} , 100 V, 5 ms / div.

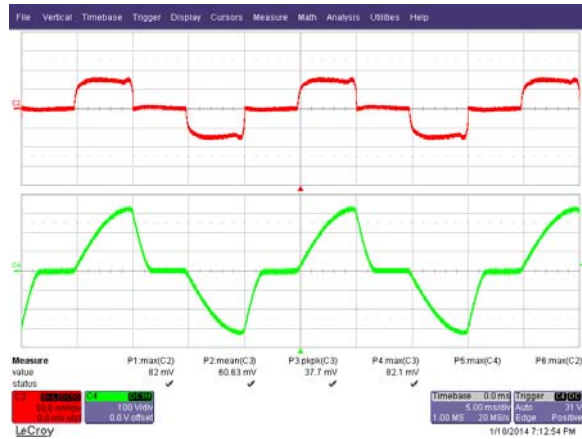

Figure 55 – 120°Conduction Angle.
 Upper: I_{IN} , 50mA / div.
 Lower: V_{IN} , 100 V, 5 ms / div.

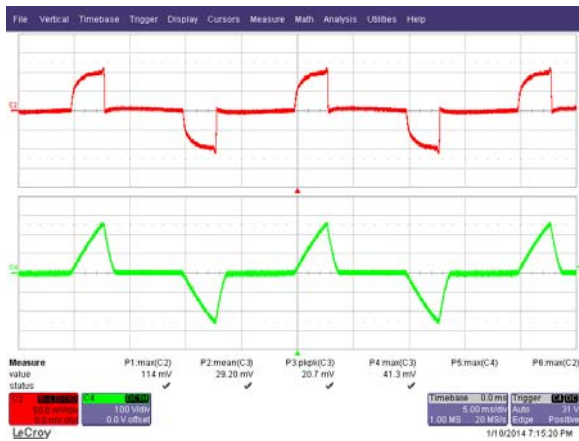

Figure 56 – 54°Conduction Angle.
 Upper: I_{IN} , 50mA / div.
 Lower: V_{IN} , 100 V, 5 ms / div.



Figure 57 – 43°Conduction Angle.
 Upper: I_{IN} , 50mA / div.
 Lower: V_{IN} , 100 V, 5 ms / div.

13.4 输出电流波形 – 后沿调光器

Input: 230VAC, 50 Hz

Output: 120 V LED Load

Dimmer: PEHA 433HAB

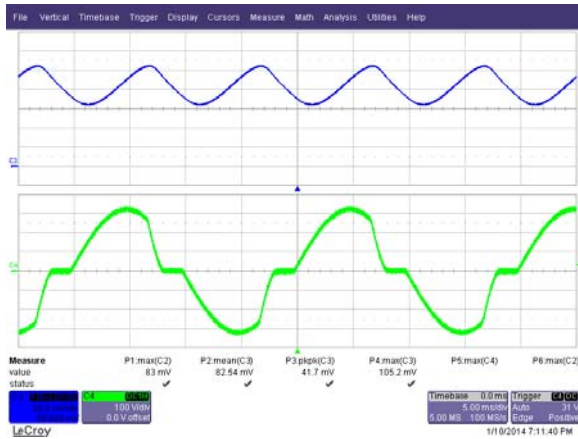

Figure 58 – 124° Conduction Angle.
Upper: I_{OUT} , 20mA / div.
Lower: V_{IN} , 100 V, 5 ms / div.

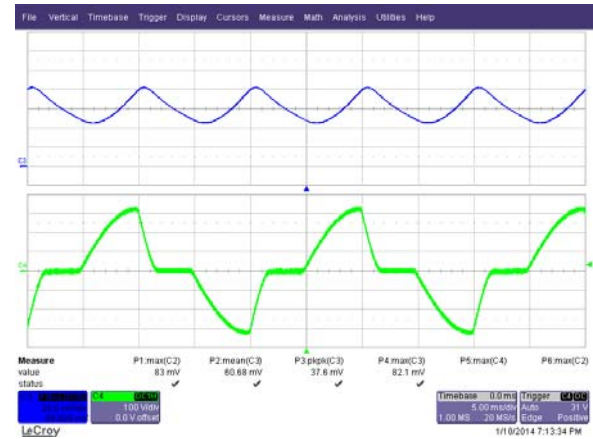

Figure 59 – 90° Conduction Angle.
Upper: I_{OUT} , 20mA / div.
Lower: V_{IN} , 100 V, 5 ms / div.

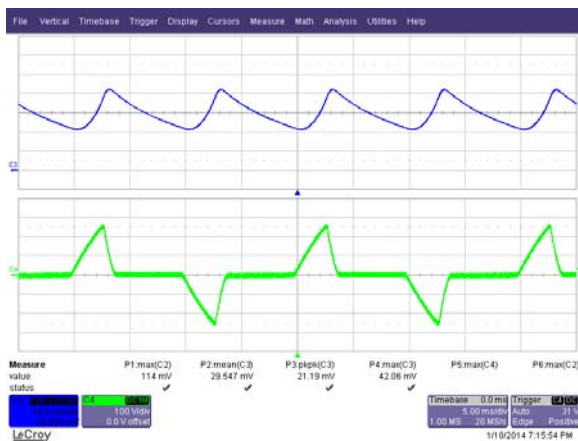

Figure 60 – 54° Conduction Angle.
Upper: I_{OUT} , 10mA / div.
Lower: V_{IN} , 100 V, 5 ms / div.

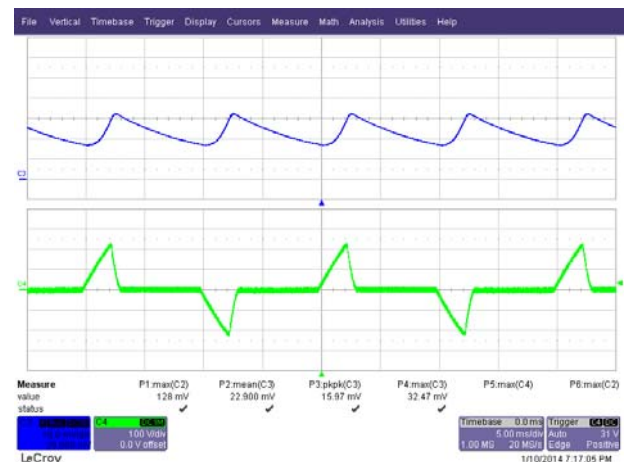

Figure 61 – 43° Conduction Angle.
Upper: I_{OUT} , 10mA / div.
Lower: V_{IN} , 100 V, 5 ms / div.



13.5 漏极电流波形 – 前沿调光器

Input: 230VAC, 50 Hz
 Output: 120 V LED Load
 Dimmer: WDE300F-1

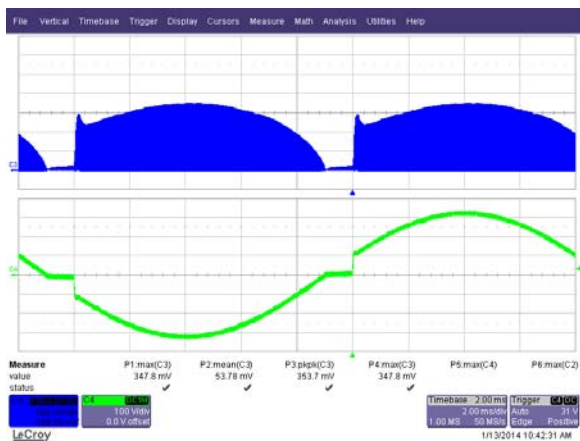

Figure 62 – 162°Conduction Angle.
 Upper: U1 I_{DS}, 100mA / div.
 Lower: V_{IN}, 100 V, 2 ms / div.

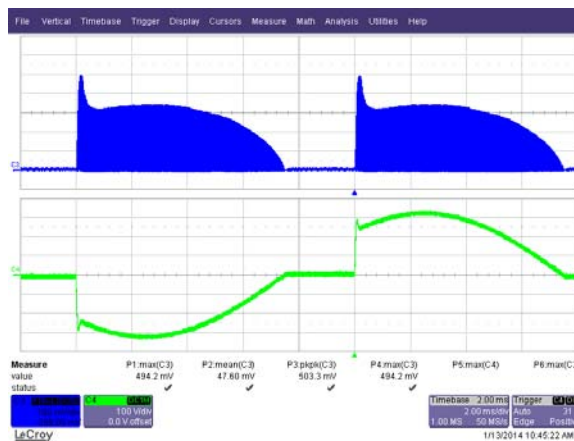

Figure 63 – 135°Conduction Angle.
 Upper: U1 I_{DS}, 100mA / div.
 Lower: V_{IN}, 100 V, 2 ms / div.

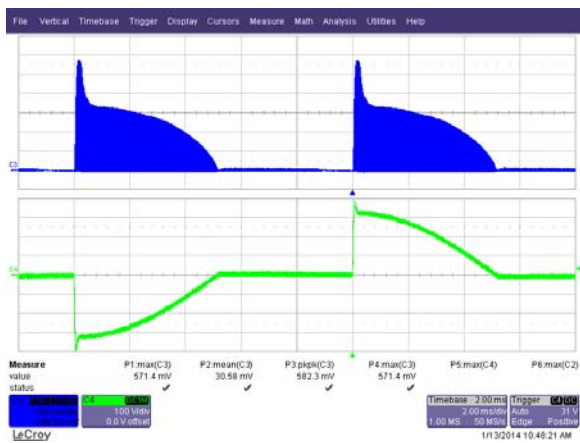

Figure 64 – 90°Conduction Angle.
 Upper: U1 I_{DS}, 100mA / div.
 Lower: V_{IN}, 100 V, 2 ms / div.

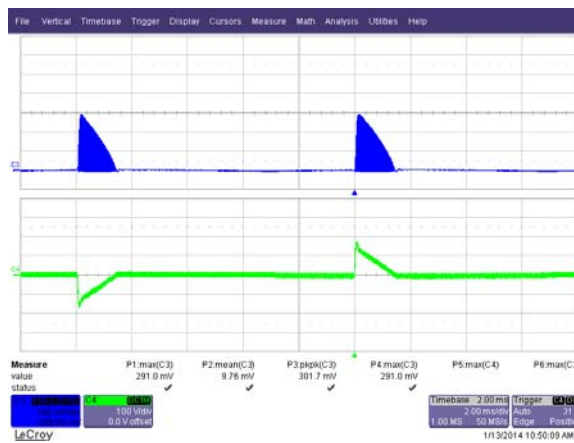

Figure 65 – 30°Conduction Angle.
 Upper: U1 I_{DS}, 100mA / div.
 Lower: V_{IN}, 100 V, 2 ms / div.

14 传导EMI

14.1 测试设置

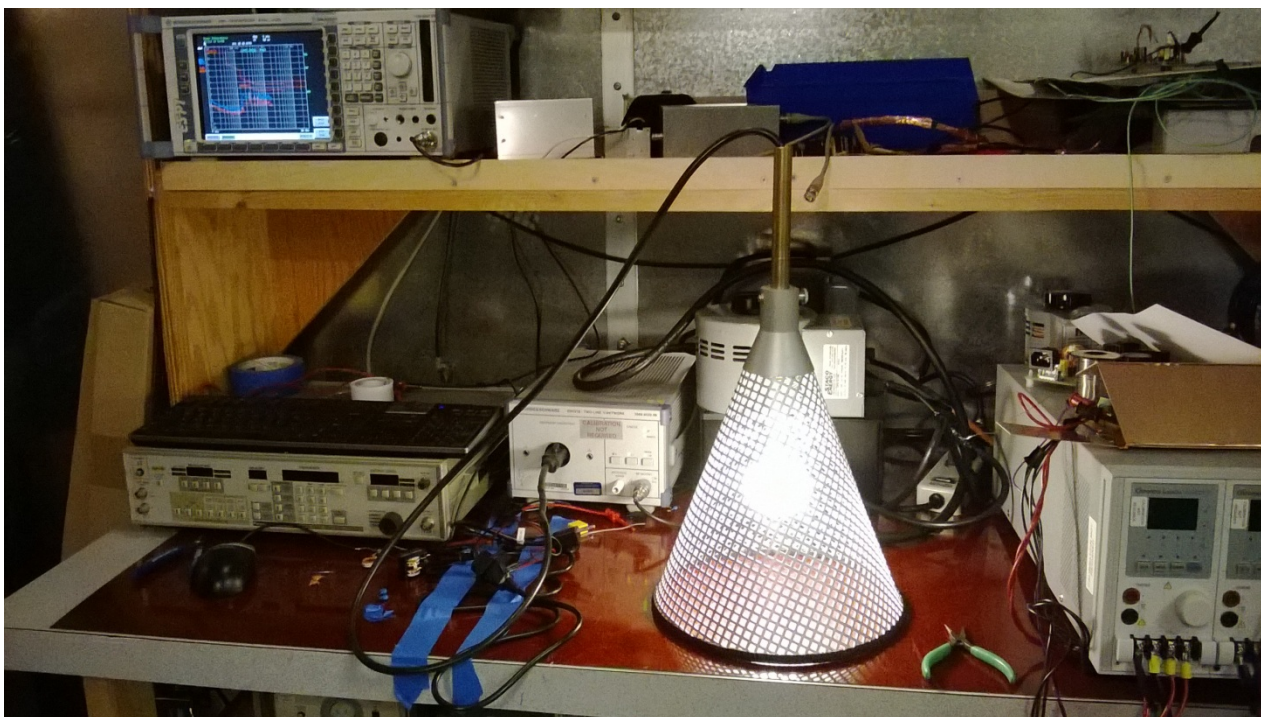

Figure 66 – Conducted EMI Test Set-up.



14.2 测试结果



Power Integrations
04.Feb 14 18:25

RBW 9 kHz
MT 500 ms

Att 10 dB AUTO

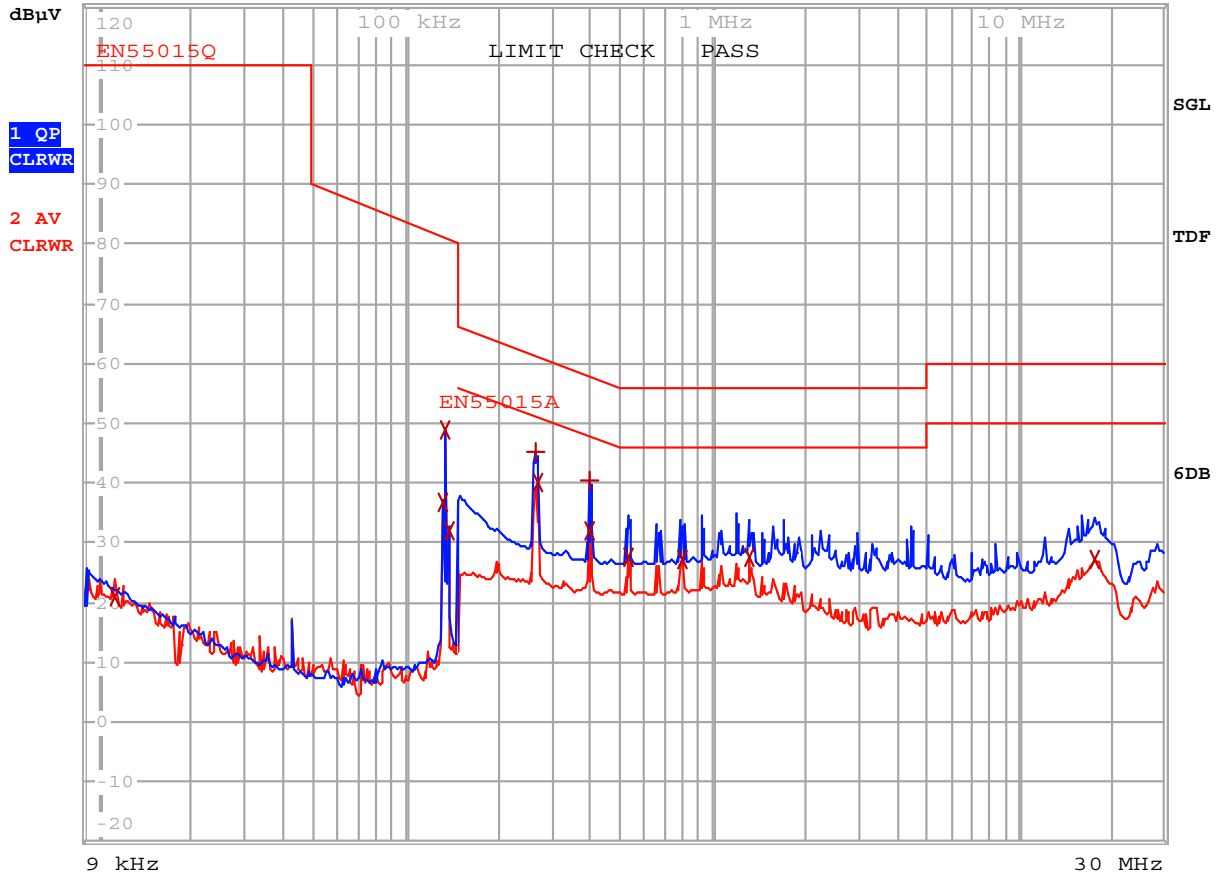

Figure 67 – Conducted EMI, ~120V LED Load, 230 VAC, 60 Hz, and EN55015 B Limits.



EDIT PEAK LIST (Final Measurement Results)						
Trace1:	EN55015Q					
Trace2:	EN55015A					
Trace3:	---					
TRACE		FREQUENCY	LEVEL	dB μ V		DELTA LIMIT dB
2	Average	11.2024427378 kHz	21.11	N	gnd	
2	Average	130.825395691 kHz	36.71	L1	gnd	
2	Average	133.454986145 kHz	48.99	N	gnd	
2	Average	137.49880568 kHz	31.99	L1	gnd	
1	Quasi Peak	264.49018761 kHz	45.08	L1	gnd	-16.20
2	Average	267.135089486 kHz	40.14	L1	gnd	-11.06
1	Quasi Peak	397.727746704 kHz	40.55	L1	gnd	-17.34
2	Average	397.727746704 kHz	32.14	L1	gnd	-15.76
2	Average	530.769219795 kHz	27.42	L1	gnd	-18.57
2	Average	798.145472681 kHz	27.29	L1	gnd	-18.70
2	Average	1.32578199726 MHz	27.47	L1	gnd	-18.52
2	Average	17.7971587654 MHz	27.14	L1	gnd	-22.85

Figure 68 – Conducted EMI, Final Measurement Results.



15 输入浪涌

Differential input line 500V surge testing was completed on a single test unit to IEC61000-4-5. Input voltage was set at 230 VAC / 60 Hz.

Surge Level (V)	Input Voltage (VAC)	Injection Location	Injection Phase (°)	Test Result (Pass/Fail)
+500	230	L to N	90	Pass
-500	230	L to N	90	Pass
+500	230	L to N	0	Pass
-500	230	L to N	0	Pass

Differential ring input line surge testing was completed on a single test unit to IEC61000-4-5. Input voltage was set at 230 VAC / 60 Hz. Output was loaded at full load and operation was verified following each surge event.

Surge Level (V)	Input Voltage (VAC)	Injection Location	Injection Phase (°)	Test Result (Pass/Fail)
+2500	230	L to N	90	Pass
-2500	230	L to N	90	Pass
+2500	230	L to N	0	Pass
-2500	230	L to N	0	Pass

Unit passed under all test conditions.

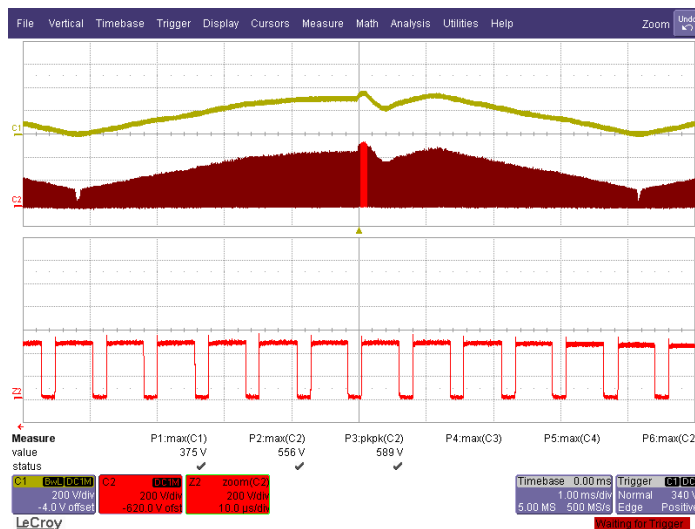

Figure 69 – 500V Differential Surge. 589V maximum VDS.

16 版本历史

Date	Author	Revision	Description andChanges	Reviewed
9-Jun-14	CA	1.0	Initial Release	Apps &Mktg



有关最新产品信息，请访问：www.powerint.com

Power Integrations reserves the right to make changes to its products at any time to improve reliability or manufacturability. Power Integrations does not assume any liability arising from the use of any device or circuit described herein. POWER INTEGRATIONS MAKES NO WARRANTY HEREIN AND SPECIFICALLY DISCLAIMS ALL WARRANTIES INCLUDING, WITHOUT LIMITATION, THE IMPLIED WARRANTIES OF MERCHANTABILITY, FITNESS FOR A PARTICULAR PURPOSE, AND NON-INFRINGEMENT OF THIRD PARTY RIGHTS.

PATENT INFORMATION

The products and applications illustrated herein (including transformer construction and circuits' external to the products) may be covered by one or more U.S. and foreign patents, or potentially by pending U.S. and foreign patent applications assigned to Power Integrations. A complete list of Power Integrations' patents may be found at www.powerint.com. Power Integrations grants its customers a license under certain patent rights as set forth at <http://www.powerint.com/ip.htm>.

The PI Logo, TOPSwitch, TinySwitch, LinkSwitch, LYTSwitch, DPA-Switch, PeakSwitch, CAPZero, SENZero, LinkZero, HiperPFS, HiperTFS, HiperLCS, Qspeed, EcoSmart, Clampless, E-Shield, Filterfuse, StackFET, PI Expert and PI FACTS are trademarks of Power Integrations, Inc. Other trademarks are property of their respective companies. ©Copyright 2013 Power Integrations, Inc.

Power Integrations全球销售支持网络

全球总部

5245 Hellyer Avenue
San Jose, CA 95138, USA.
Main: +1-408-414-9200
Customer Service:
Phone: +1-408-414-9665
Fax: +1-408-414-9765
e-mail: usasales@powerint.com

德国

Lindwurmstrasse 114
80337, Munich
Germany
Phone: +49-895-527-39110
Fax: +49-895-527-39200
e-mail: eurosales@powerint.com

日本

Kosei Dai-3 Building
2-12-11, Shin-Yokohama,
Kohoku-ku, Yokohama-shi,
Kanagawa 222-0033
Japan
Phone: +81-45-471-1021
Fax: +81-45-471-3717
e-mail: japansales@powerint.com

台湾

5F, No. 318, Nei Hu Rd.,
Sec. 1
Nei Hu District
Taipei 11493, Taiwan R.O.C.
Phone: +886-2-2659-4570
Fax: +886-2-2659-4550
e-mail: taiwansales@powerint.com

中国（上海）

Rm 2410, Charity Plaza, No. 88,
North Caoxi Road,
Shanghai, PRC 200030
Phone: +86-21-6354-6323
Fax: +86-21-6354-6325
e-mail: chinasales@powerint.com

印度

#1, 14th Main Road
Vasanthanagar
Bangalore-560052
India
Phone: +91-80-4113-8020
Fax: +91-80-4113-8023
e-mail: indiasales@powerint.com

韩国

RM 602, 6FL
Korea City Air Terminal B/D,
159-6
Samsung-Dong, Kangnam-Gu,
Seoul, 135-728 Korea
Phone: +82-2-2016-6610
Fax: +82-2-2016-6630
e-mail: koreasales@powerint.com

欧洲总部

1st Floor, St. James's House
East Street, Farnham
Surrey GU9 7TJ
United Kingdom
Phone: +44 (0) 1252-730-141
Fax: +44 (0) 1252-727-689
e-mail: eurosales@powerint.com

中国（深圳）

3rd Floor, Block A,
Zhongtuo International Business
Center, No. 1061, Xiang Mei Rd,
FuTian District, ShenZhen,
China, 518040
Phone: +86-755-8379-3243
Fax: +86-755-8379-5828
e-mail: chinasales@powerint.com

意大利

Via Milanese 20, 3rd. Fl.
20099 Sesto San Giovanni
(MI) Italy
Phone: +39-024-550-8701
Fax: +39-028-928-6009
e-mail: eurosales@powerint.com

新加坡

51 Newton Road,
#19-01/05 Goldhill Plaza
Singapore, 308900
Phone: +65-6358-2160
Fax: +65-6358-2015
e-mail: singaporesales@powerint.com

技术支持热线

World Wide +1-408-414-9660

技术支持传真

World Wide +1-408-414-9760

